

I-O Print Box Cx

User's Guide

Version 1.6

I-O Print Box Cx DXBXPP-OMAN01-160 © 2000 I-O Corporation	Version 1.6 Revision Date: February, 2000
---	--

U.S.A.: I-O Corporation
2256 South 3600 West
Salt Lake City, Utah 84119
(801) 973-6767 • Fax: (801) 974-5683

I-O Corporation (UK): I-O Corporation (UK)
9 Centurion Court, Kiln Farm,
Milton Keynes MK11 3JB
United Kingdom
44(0)1908 567722 • Fax: 44(0)1908 565599

International: I-O Corporation
2256 South 3600 West
Salt Lake City, Utah 84119
(801) 973-6767 • Fax: (801) 974-5683

Customer Support: I-O Corporation
2256 South 3600 West
Salt Lake City, Utah 84119
(801) 972-1446 • Fax: (801) 973-8042

Internet: <http://www.iocorp.com>

This page left intentionally blank.

PREFACE

I-O Corporation (I-O) is pleased to introduce you to the I-O Print Box CxP plus, CxS plus, and I-O Print Box CxP lite. With the wide range of printing environments found in business today, you can depend on the quality and reliability that has made I-O the leader in printer interface technology.

The five sections contained in the User's Guide will give you the information needed to get the most from your I-O Print Box.

INTRODUCTION - Provides an overview of the I-O Print Box CxP plus, CxS plus and CxP lite, including printer emulations, printers supported, and the adapter cables required for connectivity.

INSTALLATION - Explains how to install the I-O Print Box and how to connect to the host.

CONFIGURATION - Explains the use of the interface's on-board configuration switches, PC setup software, and host download commands.

OPERATION - Provides a detailed overview printer sharing, PC/LAN printing, laser printing, and Command Pass-Thru™.

PROBLEM RESOLUTION - Provides a detailed troubleshooting guide.

Great care has been taken in the preparation of this manual. If you encounter inaccuracies or omissions, please contact us at the address listed in this manual, Attn: Product Manager.

PREFACE

This page left intentionally blank.

TABLE OF CONTENTS

TABLE OF CONTENTS

- 1 INTRODUCTION**1-1
 - Description of Front Panels1-1
 - Configuration Switches1-2
 - About This User's Guide1-3
 - Unpacking1-3

- 2 INSTALLATION**2-1
 - Power On/Off Sequence2-4
 - Self-Test Printout - CxP plus2-5
 - Self-Test Printout - CxP lite2-6
 - Self-Test Printout - CxS plus2-7
 - Page 2 of Self-Test Printouts2-8

- 3 CONFIGURATION**3-1
 - Interface Configuration3-1
 - Configuration Switch Settings3-1
 - I-O Setup Software3-3
 - Host/PC Download Commands3-4
 - Host/PC Download Command Overview3-6
 - Restoring Factory Defaults3-41

- 4 OPERATION**4-1
 - Printer Sharing4-1
 - Parallel/Serial Port Initialization4-2
 - Host Port Initialization4-2
 - Print Position and Page Length4-3
 - Laser Printing4-3
 - Selecting Fonts4-3
 - Computer Output Reduction (COR)4-4
 - Automatic Print Orientation (APO)4-5
 - Generic Mode4-8
 - Other Printer Commands4-9

TABLE OF CONTENTS

5 ADVANCED FEATURES	5-1
Command Pass-Thru™	5-1
Custom User Strings	5-2
SCS Mode Transparent Data	5-3
Color Printing	5-3
Printing Bar Codes	5-4
Overview and Examples	5-10
I-O Graphics Language™	5-16
I-O Graphics Language™ Overview	5-17
Helpful Hints	5-20
Basic Description	5-21
General Steps	5-29
Tutorial	5-30
Linking Graphical Output to a Host Application	5-36
Printing Images From The Host	5-37
6 PROBLEM RESOLUTION	6-1
Interface Self-Test	6-1
EBCDIC Hex Dump	6-3
ASCII Hex Dump	6-4
Problem Resolution Guide	6-4

APPENDICES

APPENDIX A - Font (FGID) Reference for HP LaserJet Printers
APPENDIX B - Character Sets
APPENDIX C - Serial Port Specifications
APPENDIX D - Parallel Port Specifications
APPENDIX E - Transferring Power to Pin 18

WARRANTY INFORMATION

United States	W-1
Customer On-site Repair Policy	W-3
International	W-5
Return-to-Depot Repair Policy	W-7
European	W-9
Customer On-Site Exchange Repair Policy	W-11

DECLARATION OF CONFORMITY

1 INTRODUCTION

With the I-O Print Box you have purchased a powerful, yet easy-to-operate external printer interface. The Print Box can easily be set up through on-board configuration switches, Host/PC download commands, or through the I-O setup software. The Print Box was engineered and manufactured by I-O Corporation, the largest third-party supplier of printer interfaces in the world.

The I-O Print Boxes **CxP plus** and **CxS plus** attach virtually any ASCII printer to an IBM 30XX, 43XX, 937X host, or 3174, 3274 or 3276 controller. They offer reliable emulations of IBM 3812, 4214, 4224, 3287, 3262 and 3268 printers (all non-IPDS). When connected to a laser printer operating in PCL mode, the I-O Print Box allows Computer Output Reduction (COR) and Automatic Page Orientation (APO). In addition, paper can be pulled from several sources and a multitude of fonts (printer resident or from optional cartridges) are supported.

The I-O Print Box **CxP plus** comes with a standard parallel sharing port which allows automatic sharing of the attached printer between the host and a PC or LAN. The I-O Print Box **CxS plus** comes with a standard serial sharing port.

The I-O Print Box **CxP lite** attaches virtually any dot matrix printer to an IBM 30XX, 43XX, 937X host, or 3174, 3274 or 3276 controller. It offers solid IBM 4214, 4224, 3287, 3262 and 3268 (all non-IPDS) printer emulations. The I-O Print Box **CxP lite** does not have a parallel sharing port. Its parallel input port is a PC setup port only.

Description of Front Panels

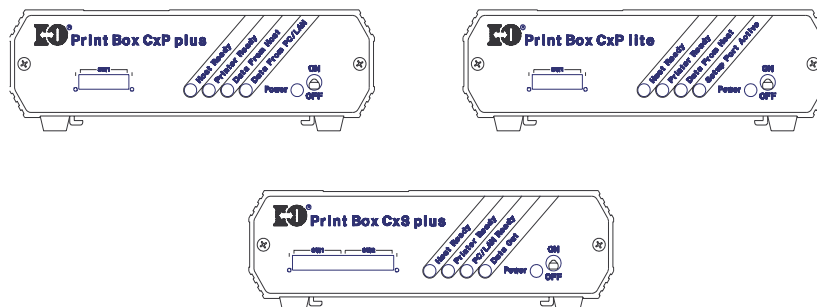

INTRODUCTION

Configuration Switches

The Configuration Switches are used to set the output protocol and to perform the available test and diagnostic functions. While the Print Box CxP models come with only one bank of switches, the Print Box CxS plus comes with two banks of eight switches. The left bank is labeled SW1, the right bank is labeled SW2.

LEDs - The green LED lights indicate the following:

Host Ready	Communication lines between the host and the interface are established.
Printer Ready	The printer is ready to receive data.
PC/LAN Ready	The interface is ready to receive serial data from an attached PC or LAN.
Data Out	The interface is currently sending data to the printer.
Data From Host	The interface is currently processing data received from the coax host.
Data From PC/LAN	The interface is currently receiving data from an attached PC or LAN. PC download commands or setup instructions sent from the I-O setup software are processed, other data is transmitted to the printer.
Setup Port Active	The interface is currently receiving download commands from an attached PC or LAN. This port cannot be used to send data to the printer.
Power	The interface is powered on.

On/Off Switch - The On/Off switch is used to power-on or power-off the interface. Use this switch when asked to cycle power.

INTRODUCTION

About This User's Guide

Since this user's guide covers three I-O Print Box models, not all sections apply to all interface models. The following identifiers are used as signals to the reader that the marked section only applies to a certain model or to certain models:

plus

Only applies to plus version printer interfaces

lite

Only applies to the lite version interface

parallel

Only applies to printer interfaces with parallel output port.

serial

Only applies to printer interfaces with serial output port.

Unpacking

Check the packaging for water or physical damage, and notify the carrier immediately if any damage is evident.

Keep the original packaging in case the interface needs to be moved or shipped.

The package should include the following:

I-O Print Box CxP plus, Print Box CxP lite, or Print Box CxS plus
Wall mount transformer (9V AC output)
Standard parallel cable (CxP plus and CxP lite)
Standard serial cable (CxS plus)
I-O Print Box Cx Quick Setup & User's Guide
I-O Setup Diskette (3.5")

INTRODUCTION

This page left intentionally blank.

2 INSTALLATION

Before connecting the I-O Print Box to the printer, verify that the printer functions properly by performing a printer self-test. Consult the printer's user's guide for instructions on how to start and evaluate the self-test. If the printer functions properly, proceed with the installation of the I-O Interface.

Note: Electrical current from power lines and cables connecting the Print Box, printer, and PC can be hazardous. To minimize the danger, follow the instructions below:

Note: Do not connect the interface to the coax cable until Step 9.

parallel

To install the I-O Print Box CxP plus or CxP lite:

1. Power off the printer and PC (if used) and disconnect the power cord(s).
2. Use the configuration switches located on the interface's front panel to select the desired output protocol. Refer to the table on page 3-1 for configuration switch settings.
3. Connect the parallel cable from the interface's "Parallel Out" connector to the printer's parallel port.
4. If the sharing port of the CxP plus is used, attach the parallel cable now. Note that a PC or LAN connected to the interface's sharing port should always be powered up when the interface is operating.
5. Connect the wall mount transformer from the outlet to the interface's "9V" connector. Connect the power cord(s) to the printer and PC (if used).
6. Power on the Print Box, then printer. The interface's green LED lights labeled "Power" and "Printer Ready" should be lit.

INSTALLATION

7. Print an interface self-test. Power off the interface. Set configuration switch SW1:8 (far right) to the "|" position. Power on the interface. After the self-test prints, set configuration switch SW1:8 back to the "o" position, then cycle the power one more time.
8. Refer to the self-test printouts (see pages 2-5 through 2-8) to determine which configuration parameters need to be altered. Change these parameters by using the setup software or Host/PC download commands.
9. With the Print Box powered off, attach the coax cable from the host to the interface's BNC connector.

Note: Whenever the printer is powered off, the Print Box must also be powered off to ensure they stay in sync with each other.

serial

To install the I-O Print Box CxS plus:

1. Power off the printer and PC (if used) and disconnect the power cord(s).
2. Use the configuration switches located on the interface's front panel to select the desired output protocol and the serial output parameters for the interface. Refer to the tables on page 3-1 for configuration switch settings.
3. Connect the serial cable from the interface's "Serial Out" connector to the printer's serial port.
4. If the sharing port is used, attach a second serial cable to the interface's "Serial In" port. Note that a PC or LAN connected to the interface's sharing port should always be powered up when the interface is operating. In addition, the PC/LAN and the interface must be using the same serial parameters. Refer to the "Printer Sharing" section on page 4-1 for more information.

INSTALLATION

5. Connect the wall mount transformer from the outlet to the interface's "9V" connector. Connect the power cord(s) to the printer and PC (if used).
6. Power on the Print Box, then the printer. The interface's green LED lights labeled "Power" and "Printer Ready" should be on. If the sharing port is used and handshaking requirements are met the LED labeled "PC/LAN Ready" should also be on.
7. Print an interface self-test. Power off the interface, then set configuration switch SW1:8 (far right on the first switch bank) to the "I" position. (If you are operating a label printer, put the printer in ASCII hex dump mode, then power on the interface. If the label printer starts printing, the interface has passed the self-test. To obtain a printout of the current settings, connect the interface to a laser or dot-matrix printer.) Power on the interface. After the self-test prints, set configuration switch SW1:8 back to the "o" position, then cycle the power one more time.
8. Refer to the self-test printouts (see pages 2-5 through 2-8) to determine which configuration parameters need to be altered. Change these parameters by using the setup software or Host/PC download commands. Refer to the Configuration section for further information.
9. With the Print Box powered off, attach the coax cable from the to the interface's BNC connector.

Note: Whenever the printer is powered off, the Print Box must also be powered off to ensure they stay in sync with each other.

The self-test printouts on the following pages show the default settings for the different I-O Print Box models. The printout you obtain may differ from the samples, since only the configuration parameters associated with the active output protocol (e.g. HP PCL, IBM PPDS, etc.) are printed. The second page of the self-test printout is the same for all Print Box models.

INSTALLATION

Power On/Off Sequence

Follow the power on and off sequences exactly, or the print output may be garbled.

To power on:

1. Turn on the printer.
2. Turn on the interface.

To power off:

1. Turn off the interface.
2. Turn off the printer.

INSTALLATION

Self-Test Printout - CxP plus

PARALLEL 3270 COAX INTERFACE
COPYRIGHT (c) 1994 SDE Corp
Rom Ok
Ram Ok
Software Version 1.00

ASCII Printer Protoco : Generic

#01 - Buffer Size (Characters) : 2 1920
#02 - Lines Density (LPI) : 6
#03 - Characters Density (CPI) : 10
#04 - Line Spacing : 1 Single (6 or 8 LPI)
#05 - Form Length (MPL) : 066
#06 - Maximum Print Position (MPP) : 080
#07 - Print Case : 1 Dual
#08 - LU1 Language : 01 English (US)
#12 - FF Before Local Screen Copy : 0 No
#13 - FF After Local Screen Copy : 0 No
#14 - LU3 Print Image (Non-SCS Mode) : 0 LU3 and Local Copy Null line suppress
#15 - CR at MPP + 1 : 0 Next line
#16 - NL at MPP +1 : 0 Current line + 2
#17 - Valid FF Followed by Data : 0 2nd PP
#18 - Valid FF at End of Buffer : 1 Line 1
#19 - FF Valid Location : 0 FF valid at 1st PP or MPP + 1
#20 - Auto Function at End of Job : 0 NL
#21 - Print Quality (Fast Draft) : 0 DP = Fast Draft, Text = Draft
#25 - IBM Motion Command : 0 Use FF
#26 - Suppress Empty Forms : 0 No
#27 - Form Feed After Time Out : 0 No
#30 - Override of Formatting Cmds : 0 Disabled
#31 - Truncate/Wrap select : Wrap text beyond MPP
#34 - Interv Required (IR) Timeout : 120 times 5 seconds
#36 - Suppress IBM Control Codes : 0 No control codes suppressed
#37 - Vertical Channel Select (VCS) : 1 3268/4224
#39 - CPT End Delimiter (ASCII) : 2625 (&%)
#40 - CPT Start Delimiter (ASCII) : 2625 (&%)
#41 - Command ID Char (ASCII) : 5A (Z)
#42 - Start/Stop Buffer Hex Dump : 0 No Action
#45 - SCS TRN Translate : 1 3287 emulation, SCS code 35
#50 - Sharing Port Timeout : 08 Seconds
#51 - Host Port Timeout : 08 Seconds
#65 - Character Set Selection : 1 Roman 8

#56 - Parallel Port Init String:
SP:

#57 - Host Port Init String:
HP:

INSTALLATION

Self-Test Printout - CxP lite

PARALLEL 3270 COAX INTERFACE
FOR DOT MATRIX PRINTERS
COPYRIGHT (c) 1994 SDE Corp
Rom Ok
Ram Ok
Software Version 1.00

ASCII Printer Protocol: Generic

#01 - Buffer Size (Characters): 2 1920
#02 - Lines Density (LPI): 6
#03 - Characters Density (CPI): 10
#04 - Line Spacing: 1 Single (6 or 8 LPI)
#05 - Form Length (MPL): 066
#06 - Maximum Print Position (MPP): 080
#07 - Print Case: 1 Dual
#08 - LU1 Language: 01 English (US)
#12 - FF Before Local Screen Copy: 0 No
#13 - FF After Local Screen Copy: 0 No
#14 - LU3 Print Image (Non-SCS Mode): 0 LU3 and Local Copy Null line suppress
#15 - CR at MPP + 1: 0 Next line
#16 - NL at MPP +1: 0 Current line + 2
#17 - Valid FF Followed by Data: 0 2nd PP
#18 - Valid FF at End of Buffer: 1 Line 1
#19 - FF Valid Location: 0 FF valid at 1st PP or MPP + 1
#20 - Auto Function at End of Job: 0 NL
#21 - Print Quality (Fast Draft): 0 DP = Fast Draft, Text = Draft
#25 - IBM Motion Command: 0 Use FF
#26 - Suppress Empty Forms: 0 No
#27 - Form Feed After Time Out: 0 No
#30 - Override of Formatting Cmds: 0 Disabled
#31 - Truncate/Wrap select: Wrap text beyond MPP
#34 - Interv Required (IR) Timeout: 120 times 5 seconds
#36 - Suppress IBM Control Codes: 0 No control codes suppressed
#37 - Vertical Channel Select (VCS): 1 3268/4224
#39 - CPT End Delimiter (ASCII): 2625 (&%)
#40 - CPT Start Delimiter (ASCII): 2625 (&%)
#41 - Command ID Char (ASCII): 5A (Z)
#42 - Start Buffer Hex Dump: 0 No Action
#45 - SCS TRN Translate: 1 3287 emulation, SCS code 35
#65 - Character Set Selection: 1 Roman 8

INSTALLATION

Self-Test Printout - CxS plus

SERIAL 3270 COAX INTERFACE
COPYRIGHT (c) 1994 SDE Corp
Rom Ok
Ram Ok
Software Version 1.00

ASCII Printer Protocol	Generic
Serial Out Baud Rate	9600 Baud
Serial Out Parity	None
Serial Out Word Length	8 Bits
Serial Out Stop Bits	1 Bit
#01 - Buffer Size (Characters)	2 1920
#02 - Lines Density (LPI)	6
#03 - Characters Density (CPI)	10
#04 - Line Spacing	1 Single (6 or 8 LPI)
#05 - Form Length (MPL)	066
#06 - Maximum Print Position (MPP)	080
#07 - Print Case	1 Dual
#08 - LU1 Language	01 English (US)
#12 - FF Before Local Screen Copy	0 No
#13 - FF After Local Screen Copy	0 No
#14 - LU3 Print Image (Non-SCS Mode)	0 LU3 and Local Copy Null line suppress
#15 - CR at MPP + 1	0 Next line
#16 - NL at MPP + 1	0 Current line + 2
#17 - Valid FF Followed by Data	0 2nd PP
#18 - Valid FF at End of Buffer	1 Line 1
#19 - FF Valid Location	0 FF valid at 1st PP or MPP + 1
#20 - Auto Function at End of Job	0 NL
#21 - Print Quality (Fast Draft)	0 DP = Fast Draft, Text = Draft
#25 - IBM Motion Command	0 Use FF
#26 - Suppress Empty Forms	0 No
#27 - Form Feed After Time Out	0 No
#30 - Override of Formatting Cmds	0 Disabled
#31 - Truncate/Wrap select	Wrap text beyond MPP
#34 - Interv Required (IR) Timeout	120 times 5 seconds
#36 - Suppress IBM Control Codes	0 No control codes suppressed
#37 - Vertical Channel Select (VCS)	1 3268/4224
#39 - CPT End Delimiter (ASCII)	2625 (&%)
#40 - CPT Start Delimiter (ASCII)	2625 (&%)
#41 - Command ID Char (ASCII)	5A (Z)
#42 - Start Buffer Hex Dump	0 No Action
#45 - SCS TRN Translate	1 3287 emulation, SCS code 35
#50 - Sharing Port Timeout	08 Seconds
#51 - Host Port Timeout	08 Seconds
#65 - Character Set Selection	1 Roman 8
#76 - Serial In Baud Rate	2 9600 Baud
#77 - Serial In Word Length	8 Bits
#78 - Serial In Stop Bits	1 Bit
#79 - Serial In Parity	0 None
#56 - Parallel Port Init String:	
SP:	
#57 - Host Port Init String:	
HP:	
#55: Custom User Strings:	

INSTALLATION

Page 2 of Self-Test Printouts

U0:
U1:
U2:
U3:
U4:
U5:

#84 - Generic 6 LPI String
#85 - Generic 8 LPI String
#86 - Generic 10 CPI String
#87 - Generic 15 CPI String
#88 - Generic 12 CPI String
#89 - Generic 16.7 CPI String

SCS (LU1) EBCDIC to ASCII Translate Table

EBCDIC	40	50	60	70	80	90	A0	B0	C0	D0	E0	F0	456789ABCDEF
0	20	26	2D	9B	9D	F8	E6	5E	7B	7D	5C	30	&-¼î^{} \0
1	20	82	2F	90	61	6A	7E	9C	41	4A	20	31	/aj~AJ 1
2	83	88	B6	D2	62	6B	73	BE	42	4B	53	32	ÑøbksfBKS2
3	84	89	8E	D3	63	6C	74	FA	43	4C	54	33	Æclt°CLT3
4	85	8A	B7	D4	64	6D	75	9F	44	4D	55	34	ñâdmuDMU4
5	A0	A1	B5	D6	65	6E	76	F5	45	4E	56	35	Àçøenv%ENV5
6	C6	8C	C7	D7	66	6F	77	F4	46	4F	57	36	óúæfow¶FOW6
7	86	8B	8F	D8	67	70	78	AC	47	50	58	37	Ägpx~GPX7
8	87	8D	80	DE	68	71	79	AB	48	51	59	38	ßhgy"HOY8
9	A4	E1	A5	60	69	72	7A	F3	49	52	5A	39	ÊÃË`irzµIRZ9
A	BD	21	DD	3A	AE	A6	AD	5B	F0	D5	FD	FC	§!i:ûîÛ [Pí»■
B	2E	24	2C	23	AF	A7	A8	5D	93	96	E2	EA	.\$.#£ı´)ãö
C	3C	2A	25	40	D0	91	D1	EE	94	81	99	9A	<*@Äîÿ
D	28	29	5F	27	EC	F7	ED	F9	95	97	E3	EB	()`š¼Ú*Đš
E	2B	3B	3E	3D	E8	92	E7	EF	A2	A3	E0	E9	+; >=ÖÖÿÂËÄÖ
F	7C	AA	3F	22	F1	CF	A9	F2	E4	98	E5	20	^?"bü`·đí

DSC (LU3) DBC to ASCII Translate Table

DBC	00	10	20	30	40	50	60	70	80	90	A0	B0	0123456789AB
0	00	20	30	26	85	84	B7	8E	61	71	41	51	0&ñaqAQ
1	00	3D	31	2D	8A	89	D4	D3	62	72	42	52	=1-äÄbrBR
2	00	27	32	2E	8D	8B	DE	D8	63	73	43	53	'2.šÄcsCS
3	00	22	33	2C	95	94	E3	99	64	74	44	54	"3,ðdtDT
4	00	2F	34	3A	97	81	EB	9A	65	75	45	55	/4:ŠeuEU
5	00	5C	35	2B	C6	83	C7	B6	66	76	46	56	\5+óúÑfvFV
6	00	7C	36	AA	E4	88	E5	D2	67	77	47	57	6^đíØgwGW
7	00	DD	37	EE	98	8C	59	D7	68	78	48	58	i7ÿYæhxHX
8	3E	3F	38	F8	85	93	41	E2	69	79	49	59	>?8¼AäiyIY
9	3C	21	39	00	8A	96	45	EA	6A	7A	4A	5A	<!9 EöjzJZ
A	5B	24	E1	5E	82	A0	45	B5	6B	91	4B	92	[\$Ä^ EçkK
B	5D	BD	F5	7E	8D	82	49	90	6C	9B	4C	9D]š¼-ıLL
C	29	9C	23	F9	95	A1	4F	D6	6D	86	4D	8F)#*ÄÖmM
D	28	BE	40	60	97	A2	55	E0	6E	87	4E	80	(f@'ÄUÄnN
E	7D	FA	25	EF	81	A3	59	E9	6F	3B	4F	3B	}%ÿÈÿÖo;O;
F	7B	CF	5F	F7	87	A4	43	A5	70	2A	50	2A	{ü ¼ËCËp*P*

3 CONFIGURATION

Interface Configuration

The I-O Print Box can be configured through the interface's on-board configuration switches, user-friendly PC setup software, or by sending download commands from the host or from a PC/LAN. To ensure proper functioning of your interface, you should review all available parameters.

Configuration Switch Settings

Use the interface's configuration switches to select the output protocol and to perform the available test and diagnostic functions. Use a pointed object, such as a ball point pen, to change the switch settings. When operating, the interface will only recognize EBCDIC Hex Dump and ASCII Dump settings. All other settings are read only at power up. Whenever you change one of these settings, remember to cycle the power to activate them.

Note: If an invalid switch setting is encountered at power up, all LED lights will blink and the interface cannot operate.

Output Protocol	SW1:4	SW1:5	SW1:6	SW1:7
Hewlett-Packard PCL*	o	o		o
IBM Proprinter	o		o	
IBM PPDS	o	o	o	o
Epson ESC/P2	o	o	o	
Epson LQ (24-pin)	o			o
Epson 9-pin FX/DFX (true 15 CPI)	o			
Epson 9-pin FX/DFX (emulated 15 CPI)		o	o	o
Generic		o	o	

* This selection is not available with the I-O Print Box CxP lite.

CONFIGURATION

Tests/Diagnostic	SW1:1	SW1:8
Restore Factory Defaults		o
Self-Test	o	
EBCDIC Hex Dump	o	

Test/Diagnostic	SW1:4	SW1:5	SW1:6	SW1:7
ASCII Hex Dump				

Operating Mode	SW1:1	SW1:4	SW1:5	SW1:6	SW1:7	SW1:8
No Tests	o	Valid Output Protocol				o

The first two test functions (Restore Factory Defaults and Self-Test) are performed only if the configuration switches are set as indicated when the interface is powered up. In the case of the self-test, the interface prints a self-test at power up and then needs to be powered off. Refer to the Problem Resolution section of this user's guide for more information.

serial

The second (right) bank of switches of the I-O Print Box CxS plus is used to set up the interface for communication with the printer.

Serial Out Baud Rate	SW2:1	SW2:2	SW2:3
38,400	o	o	o
19,200	o	o	
9,600	o		o
4,800	o		
2,400		o	o
1,200		o	
600			o
300			

CONFIGURATION

Serial Out Word Length	SW2:4
7 Bits	o
8 Bits	

Serial Out Stop Bits	SW2:5
1 Bit	o
2 Bits	

Serial Out Parity	SW2:6	SW2:7
None	o	o
Odd	o	
Even		o

Serial XOn/XOff	SW2:8
Send	
Don't Send	o

I-O Setup Software

All configuration parameters not already covered through configuration switches can be changed through the I-O setup software. Before configuring your Print Box you should print a self-test. A self-test printout shows all active configuration settings. Refer to this printout to determine which parameters may need to be changed through the I-O setup software. To run this software, attach a PC or LAN printer server to the parallel sharing port (CxP plus), PC setup port (CxP lite), or the serial sharing port (CxS plus).

CONFIGURATION

Note: A printer must be connected to the interface and in "Ready" mode in order for the interface to receive data from any of the ports.

Start your PC and go to the DOS prompt. Insert the setup software into the PC. At the DOS prompt type **A:setup** and press **Enter**. The setup program will appear on the screen. Follow the instructions shown on the screen.

Note: For a description of the available configuration parameters refer to the Host/PC Download Command table shown on page 3-6.

Host/PC Download Commands

By sending download commands from the Host/PC to the I-O Print Box, you can change all configuration parameters not already covered through the configuration switches.

Most Host/PC download commands are placed in a Host/PC document or on the screen. Regardless of whether the incoming print job is a screen print, a spread sheet, or a word processing document created on either the host or PC, the interface will recognize the Host/PC download command.

The command itself will not be printed if it was entered correctly. If any part of the command is printed, the interface did not recognize the command because of a problem in the format. Check the syntax of the command and send the command again.

Note: Any data received through the PC setup port of the I-O Print Box CxP lite will not print. Therefore, the above mentioned check does not apply to download commands received through the PC setup port.

Most Host/PC download commands sent to the I-O Print Box take effect immediately and stay only in the interface's active memory. To save the changed configuration beyond a power off, Host/PC download command Z99,0 must be sent.

CONFIGURATION

Tip: Save the Host/PC download commands in a separate file. If you need to re-configure the I-O Print Box at a later time, or if you need to configure more than one I-O Print Box, just "print" the file containing your Host/PC download commands.

Take the following steps to enter a host download command.

1. Type the Command Pass-Thru delimiter **&%** (or alternate CPT beginning delimiter) in the document at the point where the command is to take effect.
2. Type an upper case "Z" (or the alternate command ID character).
3. Type the command number for the command to be used, as shown in the table.
4. Type a comma.
5. Type the value representing the desired selection. No spaces are allowed. A space or invalid character in a command causes the interface to ignore the command and resume printing from the point the error occurred.
6. A space or control character (i.e., NL, LF, CR, FF) signals the end of the download command.
7. Multiple commands can be chained together by using a slash (/) or back slash (\) to separate the commands (no spaces allowed). For example, to set the Form Length (Command 05) to 64 lines (Value 64), the Buffer Size (Command 01) to 960 characters (Value 1), and the Character Density (Command 03) to 12 CPI (Value 12), type:

&%Z05,64/Z01,1/Z03,12

8. If you want to save these commands, either end the command string with a "/Z99,0" or send another separate command string of "&%Z99,0".

CONFIGURATION

Host/PC Download Command Overview

The following table shows the Coax Host/PC Download commands and their corresponding command numbers in alphabetical order:

Host/PC Download Command	Command Number
10 CPI Command String	86
12 CPI Command String	88
15 CPI Command String	87
16.7 CPI Command String	89
6 LPI Command String	84
8 LPI Command String	85
Alternate Paper Tray Orientation (plus models only)	63
Automatic Function at End of Job	20
Automatic Print Orientation (plus models only)	61
Character Set	65
Coax Buffer Size	01
Command ID Character	41
CPI	03
CPT Ending Delimiter	39
CPT Start Delimiters	40
CR at MPP + 1	15
Custom User Strings	55
Epson Matrix Font	09
FF After Time Out	27
FF At End Of Buffer	18

CONFIGURATION

Host/PC Download Command	Command Number
FF After Local Screen Copy	13
FF Before Local Screen Copy	12
Form Length	05
Host Port Init String (plus models only)	57
Host Timeout (plus models only)	51
IBM Motion Command	25
Intervention Required Timeout	34
Laser Paper Size (plus models only)	32
Line Spacing	04
LPI	02
LU1 Language	08
Manual Paper Tray Orientation (plus models only)	64
Max Print Position	06
NL at MPP + 1	16
Override Format Commands	30
Primary Paper Tray Orientation (plus models only)	62
Paper Path	11
Parallel Port Init String (plus models only)	56
Print Active Configuration Setting	98
Print Quality	21
Print Case	07
Print Image	14
Restore Factory Default	98
Restore Previously Saved Configuration	98
Save Config in NV Memory	99

CONFIGURATION

Host/PC Download Command	Command Number
SCS Translate =	45
Serial In Baud Rate (serial only)	76
Serial In Parity (serial only)	79
Serial In Stop Bits (serial only)	78
Serial In Word Length (serial only)	77
Serial Port Init String (serial only)	58
Sharing Timeout (plus models only)	50
Start/Stop EBCDIC Hex Dump	42
Start/Stop ASCII Hex Dump	43
Suppress Empty Forms	26
Suppress Host	36
Text After FF	17
True LPI Spacing (plus models only)	38
Truncate/Wrap	31
Valid FF Location	19
Vertical Channel Select	37

Asterisks (*) identify factory default settings. Invalid commands (such as selecting 2 LPI) are ignored. The last valid setting will be unchanged. Examples in this section apply to configuration through Host/PC download only.

COMMAND 1: BUFFER SIZE

Selects logical default buffer size.

<u>VALUE</u>	<u>DESCRIPTION</u>
1	960 characters
*2	1920 characters
3	2560 characters
4	3440 characters
5	3564 characters

CONFIGURATION

Notes: This command, along with the Z99,0 command, changes the logical buffer size selection in the non-volatile memory of the interface. The logical buffer size is only reported to the host the next time the unit is powered up.

The physical buffer size is permanently set at 4K.

Example: &%Z1,3 Sets logical buffer size to 2560 characters.

COMMAND 2: LINES PER INCH

Selects default LPI.

<u>VALUE</u>	<u>DESCRIPTION</u>
3	3 LPI
4	4 LPI
*6	6 LPI
8	8 LPI

Notes: This default emulates the front panel selection on an IBM printer.

The IBM host can control the LPI unless Command 36 is used to override the host LPI commands.

Example: &%Z2,8 Sets the printer to 8 LPI default

COMMAND 3: CHARACTERS PER INCH

Selects default CPI

<u>VALUE</u>	<u>DESCRIPTION</u>
0	No default sent to printer
*10	10 CPI
12	12 CPI
15	15 CPI
16	16.7 CPI

CONFIGURATION

Note: The IBM host can control CPI unless Command 36 is used to select override of host CPI commands.

Example: &%Z3,15 Sets the printer to 15 CPI default

COMMAND 4: LINE SPACING

Selects default Line Spacing

<u>VALUE</u>	<u>DESCRIPTION</u>
*1	Single Space
2	Double Space

Example: &%Z4,2 Sets the printer to double space default

COMMAND 5: FORM LENGTH

Selects default Form Length (MPL = Maximum Print Lines).

<u>VALUE</u>	<u>DESCRIPTION</u>
000	No form length control
001	Set form length in number of lines
to	
255	
*066	Factory Default

Note: The 000 value enables the front panel selection on the printer to control the form length when Command 25 is set to value 0.

Example: &%Z5,70 Sets form length to 70 lines for A4 paper

CONFIGURATION

COMMAND 6: MAXIMUM PRINT POSITION

Selects current and default Maximum Print Position, the maximum number of characters which can be printed on each line.

<u>VALUE</u>	<u>DESCRIPTION</u>
000	Infinite line length
001	Set MPP in number of characters
to	
254	
*80	Factory Default

Notes: Normal values are 80, 132, or 198 characters. This default emulates the front panel selection on an HP printer.

MPP and the current position will not be changed by changes in CPI.

The infinite line length will place no limits on the number of characters that can be sent to the printer on a single line.

Example: &%Z6,63 Sets MPP to 63 characters

COMMAND 7: PRINT CASE

Selects default print case.

<u>VALUE</u>	<u>DESCRIPTION</u>
0	Mono case
*1	Dual case

Notes: This default only affects LU3 printing

Example: &%Z7,0 Sets default to mono case

CONFIGURATION

COMMAND 8: LU1 LANGUAGE

Selects default LU1 language.

<u>VALUE</u>	<u>DESCRIPTION</u>
*01	English (U.S.) EBCDIC
03	Austrian/German
04	Belgian
05	Brazilian
06	Canadian (French)
07	Danish/Norwegian
08	Danish/Norwegian (alt.)
09	Finnish/Swedish
10	Finnish/Swedish (alt.)
11	French
12 (same as 11)	French (alt.)
13	Austrian/German (alt.)
14	International Set 5
15	Italian
16	Japanese (English)
19	Spanish
20	Spanish (alt.)
21	Spanish Speaking
22	English (U.K.)
23 (same as 07)	Norwegian
24 (same as 09)	Swedish
25 (same as 01)	EBCDIC (alt.)
26 (same as 08)	Norwegian (alt.)
27 (same as 10)	Swedish (alt.)
28	Portuguese
29 (same as 06)	Canadian (Bilingual)
30 (same as 11)	French AZERTY (105 character)
31 (same as 14)	Swiss German
32 (same as 14)	Swiss French

Notes: This command, along with command Z99,0, changes the default LU1 language selection in the permanent memory of the interface. The command value should match the language number used in IBM CU configuration sequence number 121.

Example: &%Z8,04 Sets LU1 language to Belgian

CONFIGURATION

COMMAND 9: EPSON MATRIX FONT

Selects Epson default font, if supported by the printer.

<u>VALUE</u>	<u>DESCRIPTION</u>
*1	Draft Print Quality
2	Roman, NLQ
3	Sans Serif, NLQ
4	Courier, NLQ
5	Prestige, NLQ
6	Script, NLQ
7	OCR-B, NLQ

Example: &%Z0,2 Selects near-letter quality (Roman) as the default

plus

COMMAND 11: PAPER PATH

Selects default paper path for the Page Presentation Media (PPM) command.

<u>VALUE</u>	<u>DESCRIPTION</u>
0	Ignore the host PPM command and select the paper tray through the printer's front panel
1	Tractor feed or only one paper source used (ignore the host PPM)
*2	Cut sheet feeding from primary bin is default
3	Cut sheet feeding from alternate bin 1 is default (corresponds to PCL escape value 4)
4	Envelope feeder default
5	Manual sheet feed default
6	Manual envelope feed default
7	Epson DFX front bin or tractor

CONFIGURATION

COMMAND 11: PAPER PATH (Continued)

- | | |
|---|---|
| 8 | Epson DFX rear bin or tractor |
| 9 | Cut sheet feeding from alternate bin 2 is default (corresponds to PCL escape value 5) |

Notes: This command defines the default paper source for the Page Presentation Media (PPM) command in SCS mode. If the PPM command is received from the host, the interface always sends the paper source to the printer unless value 0 or 1 is selected.

The printer ignores the command if it does not have a secondary paper bin or an envelope feeder.

A manual sheet feed command in the SCS PPM causes the printer to wait for the operator to insert paper in the manual feed tray. This command takes effect immediately if placed on the first position of the page (line 1, position 1); otherwise, it takes effect on the next page.

Example: &%Z11,5 Selects manual sheet feed as the default source of paper.

COMMAND 12: FORM FEED BEFORE LOCAL SCREEN PRINT

Specifies whether a form feed is performed before doing local screen print.

<u>VALUE</u>	<u>DESCRIPTION</u>
*0	No form feed before local screen dump
1	Form feed before local screen dump

Notes: This command only affects the local screen copy function, not the host-initiated local copy printing, and functions only in LU3 (non-SCS) operations

Example: &%Z12,1 Performs a FF before local screen dump

CONFIGURATION

COMMAND 13: FORM FEED AFTER LOCAL SCREEN COPY

Specifies whether a form feed is performed after a local screen hard copy.

<u>VALUE</u>	<u>DESCRIPTION</u>
*0	No Form Feed after local screen dump
1	Form Feed performed after local screen dump

Notes: To use this function, the RPQ should be:

IBM 3268 RPQ SC9508
IBM 3287 RPQ MC3750
IBM 4214 OPT 20=3

This command only affects the local screen copy, not the host-initiated local copy printing, and functions only in LU3 (non-SCS) operations

Example: &%Z13,1 Performs a FF after local screen dump

COMMAND 14: LU3 PRINT IMAGE (Non-SCS Mode)

Selects Null Line Suppression or True Screen Image in LU3 printing mode.

<u>VALUE</u>	<u>DESCRIPTION</u>
*0	Null line suppression in local copy and non-SCS print
1	Null line suppression in non-SCS print and true screen image in local copy
2	True screen image in non-SCS print and null line suppression in local copy
3	True screen image in non-SCS print and true screen image in local copy

CONFIGURATION

Notes: To use this function, the RPQ should be:
IBM 3268 RPQ SC9505
IBM 3287 RPQ SC3741
IBM 4214 OPT 18=2
Available only in LU3 (non-SCS) operations

0 and 1 are only functional from CUT terminals.

Example: &%Z14,3 Prints true screen image in non-SCS print and local copy

COMMAND 15: CR at MPP + 1

Sets the printer in accordance with the RPQ installed in the control unit.

<u>VALUE</u>	<u>DESCRIPTION</u>
*0	First print position (PP) of next line
1	First PP of current line

Notes: To use this function, the RPQ should be:
IBM 3268 RPQ SC9501
IBM 3287 RPQ S30219
IBM 4214 OPT 15=1
Available only in LU3 (non-SCS) operation

Example: &%Z15,1 Prints first PP of current line as the next PP when a CR is received at MPP+1.

COMMAND 16: NL at MPP + 1

Sets the printer in accordance with the RPQ installed in the control unit.

<u>VALUE</u>	<u>DESCRIPTION</u>
*0	First PP of current line + 2 lines
1	First PP of next line

CONFIGURATION

Notes: To use this function, the RPQ should be:
IBM 3268 RPQ SC9502
IBM 3287 RPQ S30219
IBM 4214 OPT 15=1

Available only in LU3 (non-SCS) operation.

Example: &%Z16,1 Performs first PP of next line as the next PP when an NL is received at MPP+1.

COMMAND 17: VALID FF FOLLOWED BY DATA (TEXT AFTER VALID FF NOT AT END OF BUFFER)

Sets the printer in accordance with the RPQ installed in the control unit.

<u>VALUE</u>	<u>DESCRIPTION</u>
*0	Second print position of first line on next form
1	First print position (PP) of first line on next form

Notes: For the Value 1 selection, the RPQ would be:
IBM 3268 RPQ SC9503
IBM 3287 RPQ N/A
IBM 4214 OPT 16=2

Available only in LU3 (non-SCS) operation.

Example: &%Z17,1 Performs first PP of first line on next form as the next PP when a valid FF is not positioned at the end of an IBM print buffer.

COMMAND 18: VALID FF AT END OF PRINT BUFFER (TEXT AFTER FF AT END OF BUFFER)

Sets the printer in accordance with the RPQ installed in the control unit

<u>VALUE</u>	<u>DESCRIPTION</u>
0	First PP of second line on next form
*1	First PP of first line on next form

CONFIGURATION

Notes: To use this function, the RPQ should be:
IBM 3268 RPQ SC9504
IBM 3287 RPQ SC3749
IBM 4214 OPT 17=2

Available only in LU3 (non-SCS) operation.

Example: &%Z18,1 Performs first PP of first line on next form as the next PP when a valid FF is received at the end of an IBM print buffer.

COMMAND 19: FF VALID LOCATION

Sets the printer in accordance with the RPQ installed in the control unit

<u>VALUE</u>	<u>DESCRIPTION</u>
*0	FF is valid only at the first print position or at position MPP+1.
1	FF is valid anywhere it occurs.

Notes: To use this function, the RPQ should be:
IBM 3268 RPQ SC9506
IBM 3287 RPQ SC3739
IBM 4214 OPT 19=1

Available only in LU3 (non-SCS) operation.

Example: &%Z19,1 Makes FF valid anywhere it occurs

COMMAND 20: AUTOMATIC FUNCTION AT END OF JOB

Sets the printer in accordance with the RPQ installed in the control unit.

<u>VALUE</u>	<u>DESCRIPTION</u>
*0	NL is automatically executed after the buffer is completed (unless a FF, NL, or CR was last in the buffer).
1	FF is automatically executed after the print buffer is completed (unless a FF was last in the buffer).

CONFIGURATION

Notes: To use this function, the RPQ should be:
IBM 3268 RPQ SC9507
IBM 3287 RPQ SC3740
IBM 4214 OPT 20=2

Available only in LU3 (non-SCS) operation.

Do not press the form feed or line feed buttons on the front of the printer. This will cause the host and printer to lose synchronization of paper position. This command reduces the need to advance the paper.

Example: &%Z20,1 Sets the printer to issue a FF automatically at the end of the print buffer.

COMMAND 21: PRINT QUALITY (FastDraft)

Defines default print quality.

<u>VALUE</u>	<u>DESCRIPTION</u>
*0	The Page Presentation Media (PPM) commands control the quality: DP Quality (01) = FastDraft and DP Text Quality (02) = normal draft
1	All DP draft output is printed FastDraft
2	All DP draft output is printer normal draft
3	Value 0 reversed, 01 = normal and 02 = FastDraft
4	All output is Near Letter Quality

Example: &%Z21,1 Selects all DP output as FastDraft printing.

CONFIGURATION

COMMAND 25: IBM MOTION COMMANDS

Enables a Forms Feed from the host system to be converted to the required number of line feeds (beneficial when forms length is controlled by the interface).

<u>VALUE</u>	<u>DESCRIPTION</u>
*0	Pass FF from host to the printer
1	Count the lines in Command 5 and send multiple line feeds to the printer in place of the host FF
2	Ignore all IBM Motion Commands

Example: &%Z25,1 Sets the printer to count the lines specified in Command 5.

COMMAND 26: SUPPRESS EMPTY FORMS

Suppresses blank printout pages caused by form feed commands that occur at the top of a form.

<u>VALUE</u>	<u>DESCRIPTION</u>
*0	No, do not suppress empty forms
1	Yes, suppress empty forms

Notes: If selected, the interface ignores form feed commands located at the top of form position.

This command affects printing in both DSC and SCS modes. This differs from the IBM 3287, which suppresses form feed only in DSC mode.

Example: &%Z26,1 Sets the interface to suppress empty forms

CONFIGURATION

COMMAND 27: FF AFTER TIME ELAPSE

Sends a Form Feed if unprinted data remains in the print buffer for the specified coax port timeout interval in Command 51.

<u>VALUE</u>	<u>DESCRIPTION</u>
*0	No extra FF is sent
1	Send FF after timeout value

Notes: In most cases, the host application generates a termination FF and there is no need to change this command from the default.

Example: `&%Z27,1` Sends a FF after time delay selected by command 51 (default = 5 sec.) when unprinted data remains in the print buffer.

COMMAND 30: OVERRIDE OF FORMATTING COMMANDS

Enables the printer's front panel selections to control how a job is printed.

<u>VALUE</u>	<u>DESCRIPTION</u>
*0	Normal operation (disabled)
1	Formatting commands are not sent to the printer (enabled)

Notes: When active, this command overrides the interface's default selections for CPI, LPI, font, orientation, bin selection, paper size, COR and line compression.

A reset command is sent to the printer before a coax print job in order to restore the printer's front panel default selections.

This command has no effect on the special features Command Pass-Thru, user strings, initialization strings and coax host RPQs.

Example: `&%Z30,1` Sets override of formatting commands

CONFIGURATION

COMMAND 31: TRUNCATE/WRAP SELECT

Selects whether the interface truncates or wraps the text if the maximum print position is exceeded.

<u>VALUE</u>	<u>DESCRIPTION</u>
*0	Allow text to print on next line when maximum print position is exceeded
1	Truncate text beyond the maximum print position

Example: &%Z31,1 Causes text that exceeds the maximum print position to be truncated (not printed)

plus

COMMAND 32: PAPER SIZE

HP PCL only. Specifies the paper size used for printing

<u>VALUE</u>	<u>DESCRIPTION</u>
*0	Selects 8 1/2" x 11" letter paper
1	Selects A4 (210mm x 297mm, 8.27" x 11.69") paper
2	Selects 8 1/2" x 14" legal paper
3	Selects 11" x 17" paper
4	Selects A3 size paper
5	Printer selected

Example: &%Z32,1 Selects A4 paper

COMMAND 34: INTERVENTION REQUIRED (IR) TIMEOUT

Sets the time interval before an intervention required signal is sent to the host after a printer error occurs. Note that the interface's setup switch #4 must be set to "0" (enabled).

<u>VALUE</u>	<u>DESCRIPTION</u>
000	Never send an IR
001	IR is sent (value *5) seconds after to printer error occurs
to 255	
*120	Default, send IR after ten minutes.

CONFIGURATION

Example: &%Z34,036 Sets IR time interval to 3 minutes (36 *5)/60
 = 3 minutes

COMMAND 36: SUPPRESS IBM CONTROL CODES

This function is used to select suppression of all or some IBM control codes sent from the host system.

<u>VALUE</u>	<u>DESCRIPTION</u>
*0	Obey all IBM control codes
1	Suppress all IBM control codes
2	Suppress LPI, CPI, MPP and MPL control codes
3	Suppress CPI and MPP control codes
4	Suppress LPI and MPL control codes
5	Suppress print quality specified in the PPM command

Notes: If this command is set to 1, documents need to be formatted by sending transparent control codes to the printer using Command Pass-Thru or SCS mode transparent data.

 If value 2 is selected, the SCS pitch (CPI), line density (LPI), SHF (MPP), and SVF (MPL) commands will be suppressed (not sent to the printer).

Example: &%Z36,2 No LPI, CPI, MPP or MPL commands are sent to the printer. The document prints using the printer's defaults.

COMMAND 37: VERTICAL CHANNEL SELECT (VCS)

Specifies vertical channel select (VCS) emulation. Functions similarly to a vertical tab, except the 3287 does LF only.

<u>VALUE</u>	<u>DESCRIPTION</u>
0	3287 VCS emulation
*1	3268/4214/4224 VCS emulation

Example: &%Z37,0 Selects 3287 VCS emulation

CONFIGURATION

plus

COMMAND 38: TRUE LPI SPACING

HP PCL only. Because laser printers have a non-printable border around the edge of single sheet pages, 6 LPI and 8LPI spacing is compressed slightly to enable 66 lines and 88 lines to be printed on 11-inch long paper. This can occasionally cause a problem, especially when using preprinted forms that must align precisely. Command 38 enables a user to override the laser printer LPI compression.

<u>VALUE</u>	<u>DESCRIPTION</u>
*0	Compress the vertical LPI spacing
1	Print using true 6 and 8 LPI spacing

Note: If true LPI is selected, the user needs to adjust the document formats to allow for the reduced number of lines that can be printed per page, or the extra lines may print onto another sheet of paper.

Example: &%Z38,1 Specifies that vertical spacing prints using true 6 and 8 LPI

COMMAND 39: CPT ENDING DELIMITER CHARACTERS

Specifies the two characters to be used for the ending delimiter characters or Command Pass-Thru.

<u>VALUE</u>	<u>DESCRIPTION</u>
XXYY	XX is the ASCII hexadecimal value of the first character and YY is the ASCII hexadecimal value of the second character.

Notes: If an ending delimiter is not selected with this command, the delimited selected with Command 40 will be used as a default.

The default delimiter will no longer be active if the command is used to change it. If Command 39 and Command 40 are both entered, Command 39 must be sent after Command 40 to be active.

CONFIGURATION

One delimiter character can be specified instead of two by entering the hex code for the character followed by two zeros (e.g., &%Z39,2500 selects & as the delimiter).

A hex code that starts with 00 is invalid.

Example: &%Z39,253F Specifies the %? characters as the alternate ending delimiter characters (% ASCII hex value is 25 and ? ASCII hex value is 3F).

COMMAND 40: CPT START DELIMITER CHARACTERS

Specifies the two characters to be used for the beginning delimiter characters for Command Pass-Thru.

<u>VALUE</u>	<u>DESCRIPTION</u>
XXYY	XX is the ASCII hexadecimal value of the first character and YY is the ASCII hexadecimal value of the second character

Notes: Host download commands use the CPT beginning delimiter characters as well. The new character(s) replace the &% in front of the Z.

If you do not select an ending delimiter with Command 39, the delimiter selected with this command will be used as the default ending delimiter.

The default beginning delimiter will no longer be active if you use this command to change it.

One delimiter character can be specified instead of two by entering the hex code for the character followed by two zeros (e.g., &%Z40,2500 selects & as the delimiter).

A hex code that starts with 00 is invalid.

Example: &%Z40,253F Specifies the %? characters as the beginning delimiter characters (% ASCII hex value is 25 and ? ASCII hex value is 3F).

CONFIGURATION

COMMAND 41: COMMAND ID CHARACTER

Specifies the character that is used for the command identifier that follows the delimiter characters.

<u>VALUE</u>	<u>DESCRIPTION</u>
00	Deletes the previously selected character
ZZ	ZZ is the ASCII HEX value of the command ID character

Note: The character selected must be a hex value. You cannot use 0-9, A-L, P or U. These are reserved.

Example: &%Z41,59 Specifies "Y" as the command ID character

COMMAND 42: START/STOP EBCDIC HEX DUMP

After receiving a start command the coax interface, starting with the next buffer received, sends all host data directly to the printer as hexadecimal printing until the printer is powered off.

<u>VALUE</u>	<u>DESCRIPTION</u>
*0	No action taken
1	Start EBCDIC hex dump
2	Stop EBCDIC hex dump

Notes: This command enables the user to print the document that is in question in buffer hex dump format. Hex printing starts with the buffer after the start command.

Examples: &%Z42,1 Starts buffer hex dump printing

COMMAND 43: START/STOP ASCII HEX DUMP

After receiving a start command, the interface, starting with the next buffer received, translates all host data into ASCII (from EBCDIC) and then causes the ASCII data to print in hexadecimal form. The ASCII hex dump is performed until the printer is powered off.

CONFIGURATION

<u>VALUE</u>	<u>DESCRIPTION</u>
*0	No action taken
1	Start ASCII Hex Dump
2	Stop ASCII Hex Dump

Example: &%Z43,1 Starts ASCII hex dump printing.

COMMAND 45: SCS TRN TRANSLATE

Specifies how transparent data sent using SCS code 35 is handled.

<u>VALUE</u>	<u>DESCRIPTION</u>
0	Binary Transparent
*1	Emulate IBM 3287 Printer

Notes: Value 1 causes valid graphic characters to be printed normally (i.e., converted from EBCDIC to ASCII), while control codes and invalid graphics are printed as hyphens, and normal page formatting is maintained.

Value 0 causes the 8-bit binary codes to be sent directly to the printer just as they are received from the host.

SCS code 36 functions the same as code 35.
Available in SCS (LU1) mode only.

Example: &%Z45,0 All SCS Code 35 data is sent to the printer as binary codes without translation.

plus

COMMAND 50: SHARING PORT TIMEOUT

Selects the time interval that the interface waits for receipt of additional data from the alternate (PC/LAN) host before automatically switching to check for data from the coax host.

<u>VALUE</u>	<u>DESCRIPTION</u>
04 to 63	Time interval in number of seconds
*08	Factory default is 8 seconds

CONFIGURATION

Notes: The interface sends a reset command to the printer and restores the coax host defined format commands (i.e., LPI, PI, MPL, MPP) prior to printing data from the coax host after having printed data from the shared parallel port. Because the printer is being shared between the parallel port and the 3270 host, careful attention should be paid to setting up the PC so that jobs are not automatically terminated because the printer is busy.

This problem may be helped by setting the PC timer "off" by writing "mode lpt1:.,;" (in case of an LPT1 printer) in DOS.

Use of the DOS PRINT command or a spooling program for the PC is recommended.

If your printer supports Intelligent Emulation Switching (IES), make sure the printer's IES timeout period is less than the command 51 timeout setting.

Example: `&%Z50,10` Sets the timeout interval to 10 seconds



COMMAND 51: HOST PORT TIMEOUT

Selects the time interval that the interface waits for receipt of additional data from the coax host before automatically switching to check for data from the alternate (PC/LAN) host.

<u>VALUE</u>	<u>DESCRIPTION</u>
04 to 60	Time interval in number of seconds
*08	Factory default is 8 seconds

Notes: The alternate (PC/LAN) host is responsible for sending any needed format commands required by the printer prior to sending printable data.

If your printer supports Intelligent Emulation Switching (IES), make sure the printer's IES timeout period is less than the command 50 timeout setting.

CONFIGURATION

COMMAND 55: CUSTOM USER STRINGS

Allows the user to define up to six custom user strings, of up to 25 bytes each, which are stored in the memory of the interface and sent to the printer whenever the character delimiter, letter U, and number of the string appears in the text of the document (i.e. &%U3).

<u>VALUE</u>	<u>DESCRIPTION</u>
0-5(max. 25 bytes of ASCII hex code)	Defines the custom user string
0-5()	Deletes custom user string

Notes: To aid in readability, a single space is allowed between hex bytes, but is not included in the string.

The strings could specify a special font selection command or other custom command to be sent directly to the printer.

This command, if placed as the first printable data at the top of the page (position 1, line 1), will be sent to the printer prior to the data.

To change a custom user string, simply input the new custom user string values; the old string is automatically erased.

Example: &%Z55,3(1B01) Defines the &%U3 custom user string to send an "Escape and SOH" (1B and 01 hex) to the printer which is the double wide command).



COMMAND 56: PARALLEL PORT INITIALIZATION STRING

Allows the user to define an initialization string of up to 25 bytes, which is stored in the memory of the interface and is sent to the printer at the beginning of any printing received from the parallel port.

<u>VALUE</u>	<u>DESCRIPTION</u>
1(max. 25 bytes of ASCII hex code)	Defines the parallel port init string
1()	Deletes the parallel port init string

CONFIGURATION

Notes: To aid in readability, a single space is allowed between hex bytes but is not included in the string.

The string could specify a special font selection command or other custom command to be sent directly to the printer prior to the data that is received from the parallel shared port.

To change the initialization string, simply input the new command values. The entire old string is automatically erased.

To delete the initialization string from the NV memory, simply put nothing between the parentheses.

Example: &%Z56,1() Deletes from NV memory any hex string that had been previously defined for the parallel port initialization string.

plus

COMMAND 57: HOST PORT INITIALIZATION STRING

Allows the user to define an initialization string of up to 25 bytes, which is stored in the memory of the interface and is sent to initialize the printer for host printing after shared port printing has occurred. The interface also restores the host page format parameters after sending this string and prior to host printing. The initialization string is sent at the beginning of each page.

<u>VALUE</u>	<u>DESCRIPTION</u>
1(max. 25 bytes of ASCII hex code)	Defines the host port init string
1()	Deletes the host port initstring

Notes: To aid in readability, a single space is allowed between hex bytes but is not included in the string.

The coax port initialization string is only sent to the printer when you turn the printer on and after printing by the shared parallel port has occurred.

Host SCS commands and download commands have priority over the initialization string instructions.

CONFIGURATION

To change the initialization string simply input the new command values. The old string is automatically erased.

To delete the initialization string from the permanent memory, simply type the parentheses with nothing between them.

Example: `&%Z57,1()` Deletes from permanent memory any hex string that had been previously defined for the coax port initialization string

plus

COMMAND 58: SERIAL PORT INITIALIZATION STRING

Allows the user to define an initialization string of up to 25 bytes, which is stored in the memory of the interface and is sent to the printer at the beginning of any printing received from the serial port.

<u>VALUE</u>	<u>DESCRIPTION</u>
1(max. 25 bytes of ASCII hex code)	Defines the serial port init string
1()	Deletes the serial port init string

Notes: To aid in readability, a single space is allowed between hex bytes but is not included in the string.

The string could specify a special font selection command or other custom command to be sent directly to the printer prior to the data that is received from the serial shared port.

To change the initialization string, simply input the new command values. The entire old string is automatically erased.

To delete the initialization string from the NV memory, simply put nothing between the parentheses.

Example: `&%Z58,1()` Deletes from NV memory any hex string that had been previously defined for the serial port initialization string.

CONFIGURATION



COMMAND 61: AUTOMATIC PRINT ORIENTATION (APO)

HP PCL only. Laser printers have the ability to automatically control page orientation if the user decides to activate Auto Print Orientation (APO). Refer to the page orientation logic chart in the Computer Output Reduction section of this manual.

<u>VALUE</u>	<u>DESCRIPTION</u>
0	APO is NOT ACTIVE. Print orientation is controlled by the orientation selections specified in Commands 62, 63, and 64.
*1	APO is ACTIVE. The page dimensions of a document are checked to determine if the data should be printed in landscape because the width is greater than the length.

Note: APO active is the recommended selection. A user can manipulate the page dimensions using SCS commands to control the orientation

of the printing as long as the page size required is 8 1/2 x 11" or smaller.

Example: &%Z61,1 Enables APO



COMMAND 62: PRIMARY PAPER TRAY ORIENTATION

HP PCL only. The SCS (LU1) PPM command specifying the source for the paper can have a printing orientation assigned to the paper tray that is assigned. Refer to the page orientation logic chart in the Computer Output Reduction section of the manual. This command duplicates the IBM 3812 and 4028 printer's feature with the additional selection of option 3 below.

<u>VALUE</u>	<u>DESCRIPTION</u>
*0	Computer Output Reduction (COR) Mode is active when paper is specified to be selected from the primary tray
1	Prints PORTRAIT orientation using the active font when the primary tray is specified

CONFIGURATION

- 2 Prints LANDSCAPE orientation using the active font when the primary tray is specified
- 3 User Defined mode. Documents are printed using the fonts and orientation that the user specifies through use of the &% font ID commands.

Example: &%Z62,3 Specifies that the document is printed as formatted when the primary paper tray is specified as the paper source.



COMMAND 63: ALTERNATE PAPER TRAY ORIENTATION

HP PCL only. This command functions identically to Command 62 except it controls the orientation for printing that specifies the alternate tray for the paper source.

Even if the printer does not have an alternate paper tray, the SCS (LU1) host specifies the alternate tray, and the interface prints the document in accordance with the selection in Command 63.

Values are the same as Command 62 except substitute "alternate tray" for "primary tray" in the descriptions.

Note: the value 3 is an excellent choice when COR is not required, since the user can decide the fonts and orientation he desires by using &% font ID commands.

Example: &%Z63,2 Specifies that landscape orientation will be used for all printing in which the SCS (LU1) PPM code specifies the alternate paper tray be used.



COMMAND 64: MANUAL FEED TRAY ORIENTATION

HP PCL only. This command functions identically to Command 62 except it controls the orientation for printing when the PPM Command specifies the manual feed tray for the paper source.

CONFIGURATION

Values are the same as Command 62 except substitute "manual feed tray" in place of "primary tray" in the descriptions.

Note: The laser printer will, upon receipt of the manual feed tray command, not print until paper is placed into the manual feed slot. This allows the user to insert special forms, letter head, or colored paper into the manual feed slot.

Example: `&%Z64,1` Specifies all printing using paper from the manual feed slot be printed in portrait orientation

COMMAND 65: CHARACTER SET SELECTION

Enables the user to select the ASCII character set that is used in the conversion from EBCDIC (SCS/LU1 or DSC LU3) to ASCII. This selection automatically changes to match the output protocol selected through the interface's configuration switches if HP, PPDS or Proprinter II modes are chosen. The other selections require the user to manually select the appropriate character set.

<u>VALUE</u>	<u>DESCRIPTION</u>
1	Roman 8 (default for HP PCL)
*2	Code Page 850
3	Code Page 437
4	Code Page 858 [#]
5	Latin 1 Euro [#]

Notes: [#] The Euro symbol is supported in code page 858 for dot-matrix printers, and in the Windows 3.1 Latin 1 character set for laser printers.

The character set substitutions defined in Commands 70 and 71 must be adjusted if the ASCII character set is changed.

All previously defined substitutions are lost from NV memory when the character set selection is changed.

Refer to the character set summary tables at the end of the self test to confirm which ASCII character is printed for each of the 3270 hex codes. Both the EBCDIC and DSC tables are provided.

CONFIGURATION

Example: &%Z65,5 Selects the Latin 1 Euro character set which supports the Euro symbol.

COMMAND 70: OVERWRITE EBCDIC (SCS/LU1) TRANSLATION TABLE

Custom substitutions defined by this command and stored in permanent memory are written into the EBCDIC (SCS/LU1) to ASCII translation table.

<u>VALUE</u>	<u>DESCRIPTION</u>
XX	The EBCDIC character to be changed (in hex)
YY	The substitute ASCII character for the EBCDIC character above

Notes: Previously stored substitutions are automatically changed to the new selection when the same hex location is specified in the EBCDIC table.

Previously stored substitutions are cancelled if an ASCII hex sequence of 00 is specified.

Command Z99,0 must be used to store the substitutions in permanent memory for them to be effective when the printer is next turned on.

The active EBCDIC (SCS/LU1) translation table prints out at the end of the interface self-test summary.

Example: &%Z70,7B,40/Z99,0 Prints a 40 ASCII hex (a @ symbol) when the interface receives an EBCDIC 7B (a # symbol). The command is followed by a command Z99,0 which stores the active setup selections in permanent memory.

CONFIGURATION

COMMAND 71: OVERWRITE DSC (LU3) TRANSLATION TABLE

Custom substitutions defined by this command, and stored in the permanent memory, are overwritten into the DSC (LU3) to ASCII translation table.

Notes: This command functions similarly to Command 70 except the substitutions are applicable to the DSC (LU3) translation table. Refer to the Command 70 instructions.

The active DSC (LU3) translation table prints out at the end of the interface self-test summary.

COMMAND 76: SERIAL-IN BAUD RATE

Selects the Baud Rate for data received at the serial-in port. A new setting will not be effective immediately. To activate the new setting cycle power on the interface.

<u>VALUE</u>	<u>DESCRIPTION</u>
0	38,400 baud
1	19,200 baud
*2	9,600 baud
3	4,800 baud
4	2,400 baud
5	1,200 baud
6	600 baud
7	300 baud

Example: &%Z76,0 Sets the receiving baud rate to 38,400

COMMAND 77: SERIAL-IN WORD LENGTH

Selects the Word Length of data received at the serial-in port. A new setting will not be effective immediately. To activate the new setting cycle power on the interface.

<u>VALUE</u>	<u>DESCRIPTION</u>
7	7 Bits
*8	8 Bits

CONFIGURATION

Example: &%Z76,0 sets the receiving baud rate to 38,400

COMMAND 78: SERIAL-IN STOP BITS

Selects the number of Stop Bits of a data stream received at the serial-in port. A new setting will not be effective immediately. To activate the new setting cycle power on the interface.

<u>VALUE</u>	<u>DESCRIPTION</u>
*1	1 Bit
2	2 Bits

Example: &%Z78,2 sets the number of Stop Bits to 2

COMMAND 79: SERIAL-IN PARITY

Selects the Parity of a data stream received at the serial-in port. A new setting will not be effective immediately. To activate the new setting cycle power on the interface.

<u>VALUE</u>	<u>DESCRIPTION</u>
*0	None
1	Odd
2	Even

Example: &%Z79,2 sets the parity to even.

COMMAND 84: 6 LPI STRING

Used when operating the Generic output protocol. Defines the 6 LPI string the interface sends to the printer when the host sends a 6 LPI command.

<u>VALUE</u>	<u>DESCRIPTION</u>
1(max. 25 bytes of ASCII hex code)	Defines the 6 LPI string
1 ()	Defines the 6 LPI string

Notes: This string represents the printer-specific command to set the printer to 6 LPI. Consult your printer's manual for the appropriate hex value representing the 6 LPI command.

CONFIGURATION

Example: &%Z85,1(1B 30) Stores the 8 LPI command for an Epson 1Q-2500 printer (hex value 1B 30) as the 8 LPI string.

COMMAND 85: LPI STRING

Used when operating in Generic output protocol. Defines the 8 LPI string the interface sends to the printer when the host sends a 8 LPI command.

<u>VALUE</u>	<u>DESCRIPTION</u>
1 (max. 25 bytes of ASCII hex code)	Defines the 8 LPI string
1()	Deletes the 8 LPI string

Notes: This string represents the printer-specific command to set the printer to 8 LPI. Consult your printer's manual for the appropriate hex value representing the 8 LPI command.

Example: &%Z85,1(1B 30) Stores the 8 LPI command for an Epson LQ-2500 printer (hex value 1B 30) as the 8 LPI string.

COMMAND 86: 10 CPI STRING

Used when operating in Generic output protocol. Defines the 10 CPI string the interface sends to the printer when the host sends a 10 CPI command.

<u>VALUE</u>	<u>DESCRIPTION</u>
1(max. 25 bytes of ASCII hex code)	Defines the 10 CPI string
1()	Deletes the 10 CPI string

Example: &%Z86,1(1B 50) Stores the 10 CPI command for an Epson LQ-2500 printer (hex value 1B 50) as the 10 CPI string

COMMAND 87: 15 CPI STRING

Used when operating in Generic output protocol. Defines the 15 CPI string the interface sends to the printer when the host sends a 15 CPI command.

CONFIGURATION

<u>VALUE</u>	<u>DESCRIPTION</u>
1 (max. 25 bytes of ASCII hex code)	Defines the 15 CPI string
1 ()	Deletes the 15 CPI string

Example: &%Z87,1 (1B 67) Stores the 10 CPI command for an Epson LQ-2500 printer (hex value 1B 67) as the 15 CPI string.

COMMAND 88: 12 CPI STRING

Used when operating in Generic output protocol. Defines the 12 CPI string the interface sends to the printer when the host sends a 12 CPI command

<u>VALUE</u>	<u>DESCRIPTION</u>
1(max. 25 bytes of ASCII hex code)	Defines the 12 CPI string
1()	Deletes the 12 CPI string

Example: &%Z88,1(1B 4D) Stores the 12 CPI command for an Epson LQ-2500 printer (hex value 1B 4D) as the 12 CPI string.

COMMAND 89: 16.7 CPI STRING

Used when operating in Generic output protocol. Defines the 16.7 CPI string the interface sends to the printer when the host sends a 16.7 CPI command.

<u>VALUE</u>	<u>DESCRIPTION</u>
1(max.25 bytes of ASCII hex code)	Defines the 16.7 CPI string
1()	Deletes the 16.7 CPI string

Example: &%Z89,1(1B 10) Stores the 16.7 CPI command for an Epson LQ-2500 printer (hex value 1B 10) as the 16.7 CPI string.

CONFIGURATION

COMMAND 98: RESTORE DEFAULTS OR PRINT CONFIGURATION

Restores the factory default configuration selections, prints out a copy of the active configuration selections, or restores the permanent memory selections to the active setup status.

<u>VALUE</u>	<u>DESCRIPTION</u>
0	Restores the factory setup
1	Prints out the active setup selections
2	Restores the setup selections stored in the permanent memory to active status

Notes: If a document is printed using temporary host download commands (commands not stored using the Z99,0 command), value 2 will restore the permanent memory selections.

Put a &%Z98,2 at the end of the document to restore the standard setup parameters for the next user of the printer.

The active setup and permanent memory setup selections are the same after a Command Z99,0 or a Command Z98,2 is sent to the printer.

Example: &%Z98,1 Prints out the active setup selections for review

COMMAND 99: STORE CONFIGURATION IN PERMANENT MEMORY

Send this command after all desired host download configuration commands have been sent to the interface. It stores the active setup in the permanent memory of the interface so it will be in effect whenever the printer is powered on. Otherwise, active configuration commands are lost when the printer is turned off.

<u>VALUE</u>	<u>DESCRIPTION</u>
0	To complete the command, the value 0 must be used

Notes: Host download selections followed by a Command Z99,0 will be stored in permanent memory and active when the printer is turned on. Only use Command Z99,0 when the host download selection needs to be permanently stored in the memory of the interface.

CONFIGURATION

Example: &%Z99,0 Stores the currently active setup selections in the permanent memory of the interface.

Restoring Factory Defaults

The factory default configuration can be restored by either sending Host/PC Download Command "Z98,0" or by taking the following steps:

1. Power off the printer and the Print Box.
2. Disconnect the host and PC sharing cables from the interface.
3. Set configuration switch SW1:1 (far left) to the " " position and switch SW1:8 (far right of the first bank of switches) to the "o" position if it is not already there.
4. Power on the Print Box. The factory defaults are restored. The LED lights labeled "Host Ready" and "Printer Ready" will blink continuously, indicating the Print Box is not in operating mode.
5. Power off the Print Box and return configuration switch SW1:1 (on the first bank of switches) to the "o" position. Switch SW1:8 should be in the "o" position as well.

CONFIGURATION

This page left intentionally blank.

4 OPERATION

plus**Printer Sharing**

The I-O Print Box CxP plus and CxS plus allow the printer to automatically be shared between an attached PC/LAN and an IBM coax host. Simply connect the PC/LAN printer server to the parallel/serial port. The Print Box CxP plus can supply external devices attached to its parallel sharing port with 5V up to 350 mA. See Appendix E for instructions on how to transfer power to pin 18 on the Print Box CxP plus. The interface uses a timeout after each print job before it honors print jobs from another port.

At the end of a host print job, the interface waits for the specified Host Port Timeout period before it honors data streams coming in through the parallel port. The Host Port Timeout period is set through Host/PC download command 51 or through the setup software.

After a parallel or serial print job is completed, the interface will again wait for a period of time before it honors host print jobs. The Sharing Port Timeout is set through Host/PC download command 50 or through the I-O setup software.

If the PC print job is sent while a host job is printing, the printer responds as "busy" to the PC print request. The print job can be spooled through a spool program, sent to the printer when the host job is finished or if the PC's printer port is set for infinite retry through the DOS "Configure Printer" command (described in the DOS manual), the print job waits for the printer to be available to receive the data.

serial

By default, the I-O Print Box CxS plus sends data at 96N81 (9,600 baud; parity = none; word length = 8 bits; stop bits = 1). Make sure that the printer and the I-O Print Box are using the same serial parameters. The interface's Serial-Out parameters can be changed using the second (right) bank of switches located on the front panel.

Also ensure that the Print Box's Serial-In settings are the same as that of the PC/LAN. Note that when printing from the share port, the slowest baud rate (Serial-In, Serial-Out) will determine the print speed.

OPERATION

The interface's Serial In parameters can be changed through Host/PC download commands 76 through 79 or through the setup software.



PC printing longer than 10 to 20 minutes (depending on host configuration) may cause the 3270 host to drop communication with the printer ("go to sleep").

The output protocol specified in the interface's configuration (through configuration switch settings) is irrelevant for printing from the shared port. For PC/LAN printing, select the appropriate printer driver on the PC/LAN printer server.



Parallel/Serial Port Initialization

If you want to change the printer's configuration for shared printing (e.g. set it to PostScript mode), use the parallel or serial port initialization string (Host/PC download command 56 for parallel; command 58 for serial). Consult the printer's user's guide for the ASCII hex values representing the desired configuration commands. Then store these commands in the interface's memory using Host/PC download commands 56 or 58, or the I-O setup software.

After the host printing is completed and before the print job from the shared port is sent to the printer, the interface will send this initialization string to the printer and configure it according to your instructions. However, it is possible that the print job coming through the parallel or serial shared port contains other printer instructions, thus overriding the parallel initialization string.



Host Port Initialization

After shared printing, the I-O Print Box reconfigures the printer according to the active configuration settings. If you want to further modify the printer configuration (e.g. select a different font for all host printing) take advantage of the host port initialization string. Unlike the Parallel or Serial Port Initialization String, which is usually overridden by commands coming with the PC/LAN print job, the Host Port Initialization String is not sent to the printer until after the interface has reconfigured the printer for host printing. The Initialization String is sent at the beginning of each printed page.

OPERATION

plus Print Position and Page Length

The table below outlines the PMPP (Physical Maximum Print Position) and PMPL (Physical Maximum Page Length) for letter, legal, and A4 size paper.

Paper Size	PMPP at				PMPL at			
	10 CPI	12 CPI	15 CPI	17.1 CPI	6 LPI	8 LPI	True 6 LPI	True 8 LPI
Letter								
Portrait	80	96	120	136	66	88	63	84
Landscape	105	126	157	178	50	87	48	84
COR	136	154	201	201	66	89	--	--
Legal								
Portrait	80	96	120	136	84	112	81	108
Landscape	135	162	202	230	50	67	48	64
A4								
Portrait	78	93	117	133	70	93	67	89
Landscape	112	134	167	191	49	66	47	62

plus Laser Printing

Selecting Fonts

A printer-resident font or a font from an optional font cartridge can be selected in the printer by entering a font change command in the document. The font change commands take the following format:

& %[P or L][font ID]

The &% (or the alternate beginning delimiter selected with command 40) is the delimiter that signals the interface that the information following is a command. The letter P or L controls the orientation of the printing: P for portrait and L for landscape printing. The font ID number selects the font to be used for printing. The font ID should be five digits in length. Refer to Appendix A for a list of fonts and the font IDs available for the printer.

OPERATION

For example:

&%L00086 selects a Prestige 12 CPI font in landscape orientation.

The font ID number must select a font available in the printer or in the installed cartridge. If the proper cartridge is not installed, or the font does not exist on the cartridge, then the printer will automatically select an alternate font for printing. Multiple font changes can be made in a document as long as all fonts are in the same orientation. Changes in orientation (portrait or landscape) automatically eject the page. A font ID that changes the orientation from the previous page must be on the first line and first position of the page or a blank page will be ejected. A blank page at the first of a print job is often caused by a change in orientation. Command 61 must be set to "0" (APO Inactive), Commands 62-64 must be set to "3" (User Defined).

plus Computer Output Reduction (COR)

Computer Output Reduction (COR) is an IBM printer feature that automatically rotates data processing reports to landscape orientation and compresses the text to fit 198 columns x 66 lines on the page. COR is enabled by doing the following:

1. Select APO active with command 61 (value 0).
2. Select COR for the paper source with commands 62-64 (value 0).

When COR is enabled, the following format changes are automatically made to data processing reports:

- The page is printed in landscape orientation.
- Vertical line height is 70% of that specified.
- An 0.5-inch blank area is provided on the top and left edge of the paper.
- The selected pitch is changed: 10 pitch to 13.3 pitch; 12 pitch to 15 pitch; 15 pitch to 19 pitch.

OPERATION

A combination of control codes in the printer data stream and the settings in the configuration are used to determine page orientation when processing DSC, DSE, or LU1 (SCS) data streams.

Some applications will not allow the user to insert the data stream commands required to achieve orientation and format selection. Where the insertion of the required data stream commands is not possible, the user can select the orientation and format desired by using the printer configuration settings. Use of the Write Control Character (WCC) in the DSC/DSE data streams for orientation and format selection is not recommended.



Automatic Print Orientation (APO)

When Automatic Print Orientation (APO) is activated (command 61, value 1), the Print Box notes the format of the print image and calculates the required print dimensions. The illustration on the page 4-7 shows how the page size determines the orientation for coax COR.

If a calculated paper size is larger than 8 1/2" x 11", the paper tray orientation selection (commands 62-64) determines the orientation.

In LU3 (DSC/DSE) mode, the values used in the calculations are specified by the interface's active configuration selections. In LU1 (SCS) mode, the values are specified in the data stream by the SCS controls. If a value has not been set in the SCS data stream, the interface's active configuration is used instead.

The APO feature also uses the calculated print width and length to determine the print orientation when the dimensions are less than 8 1/2" x 11". When the width is greater than the length and APO is active, the document prints in landscape, even if the font is specified as portrait.

The following steps describe printing with the APO feature (refer to the illustration on page 4-7).

1. If APO is not active (command 61, value 0), the interface uses the paper source selections (commands 62-64) to control orientation in the active font. If APO is active, the report continues to block 2.

OPERATION

2. The interface calculates the page size. If the page size is more than 8 1/2" x 11" the interface uses the paper source selections to control the orientation in the active font. If the report is less than 8 1/2" x 11" it continues to block 3.
3. At block 3, the interface checks the length and width. If the report is longer than it is wide, it prints in portrait. If the report is wider than it is long, the report prints in landscape.

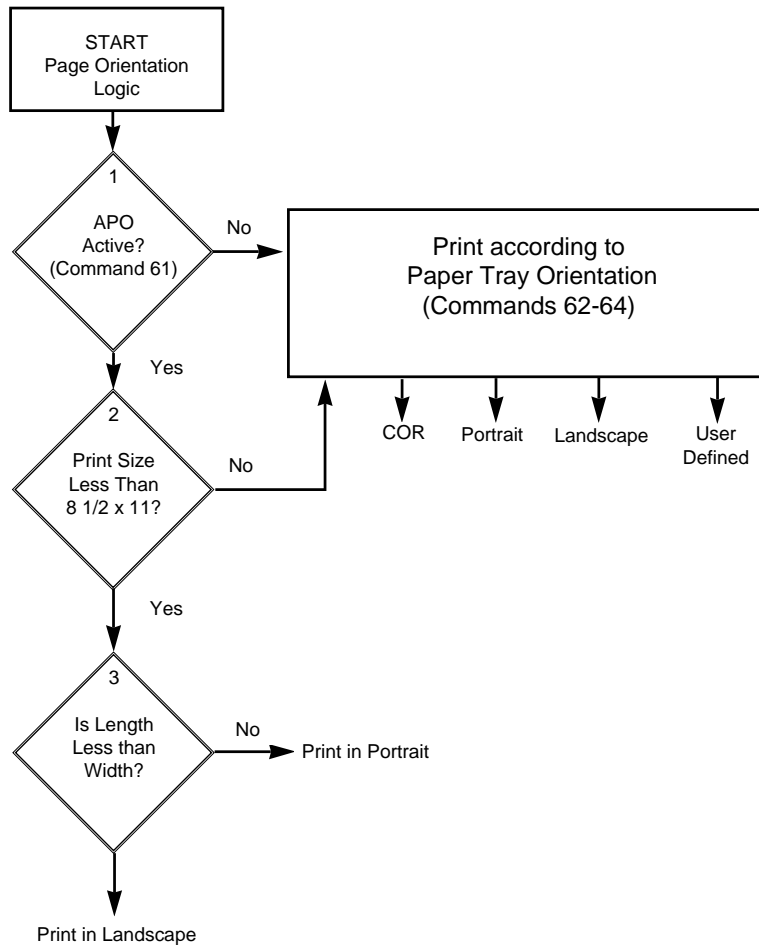

OPERATION

Generic Mode

The Generic output protocol should be used when the other output protocols of the I-O Print Box are inappropriate. This could be the case with printers such as certain barcode label printers or embossers, but also with printers from Okidata, Mannesmann-Tally, etc. Refer to the printer's user's guide to find out if the printer operates with one of the output protocols of the I-O Print Box.

In Generic mode, the interface does not pass on the LPI and CPI commands from the host. Rather, it allows you to match the printer specific CPI or LPI command with the CPI or LPI command from the host (through Host/PC download commands 84-89).

For example, the printer protocol a printer requires is not available on the I-O Print Box. To change the printer to 10 CPI, the printer's user's guide provides the hexadecimal value of 1B 50. Use the Host/PC download command 88 to assign the value 1B 50 to the 10 CPI string (type &%Z88,1(1B 50)). From now on, when the interface receives a request for 10 CPI from the host, it will send the value 1B 50 to the printer and thereby set it to 10 CPI.

If nothing is assigned to the CPI or LPI string, the interface will send nothing to the printer, i.e. it will ignore the CPI or LPI command from the host.

The interface stores commands for the following CPI and LPI values:

6 LPI	Host/PC download command 84
8 LPI	Host/PC download command 85
10 CPI	Host/PC download command 86
15 CPI	Host/PC download command 87
12 CPI	Host/PC download command 88
16.7 CPI	Host/PC download command 89

Other Printer Commands

You can also enter commands into your document that allow you to control true LPI and response to host commands. These commands (shown below) are similar to font change commands.

Command	Function
<code>¬E</code>	Sends an ASCII ESC command to the printer
<code>¬TY</code>	Enables true LPI printing
<code>¬TN</code>	Disables true LPI printing
<code>¬I</code>	Ignores all host formatting commands
<code>¬S</code>	Stops ignoring host formatting commands

The `¬E` command allows you to send an escape command to the printer to control the printing. For example, `¬E(s3B` would begin bold printing (see your printer's manual for a list of the printer or escape commands).

The printer may compress line spacing to fit 66 lines onto the page. This may be undesirable, such as when using pre-printed forms that must align correctly. In these cases, the `¬TY` command prevents the printer from compressing the line spacing.

Use the `¬I` and `¬S` commands to remove unwanted host commands from a print file. For example, when printing with forms-generating software, the files are recognized by the host as text files and formatted with unwanted carriage returns and line feeds. Placing the `¬I` at the end of a line and `¬S` at the front of the next line causes the interface to remove the host carriage return and line feed commands and send only the data to the printer.

OPERATION

This page left intentionally blank.

5 ADVANCED FEATURES

There are several advanced features in the I-O Print Box for accessing special functions of the printers, which are not normally available on the IBM system printers. These features include:

- Command Pass-Thru™
- Custom User Strings
- SCS Mode Transparent Data
- Color Printing
- Bar Code Printing
- I-O Graphics Language

Each of these features is described below..

Command Pass-Thru™

The Command Pass-Thru feature allows access to all of the built-in features of your printer, even if these features aren't normally available through the host software. Command Pass-Thru lets you place printer-specific command sequences into the data sent to the printer. The interface recognizes these special sequences and "passes the command through" to the printer. The steps below describe how to use Command Pass-Thru.

1. Find the command for the print feature in the printer's user's guide.
2. Convert the printer command to hexadecimal.
3. Place the beginning delimiter **&%** (or the custom delimiter as defined with command 40) in the document at the point you want the feature to take effect. This signals the start of the print feature. Enter the beginning printer command, then enter the ending delimiter **&%** (or the custom delimiter as defined with command 39). No spaces are allowed.
4. Move the cursor to the point in the text that you want to end the print feature. Enter the delimiter followed by the ending printer command and then the delimiter again, into the document.

ADVANCED FEATURES

For example:

The command **ESC &d0D** begins underlining and **ESC &d@** ends underlining. First convert the start command to the hexadecimal **1B 26 64 30 44** and the ending command to **1B 26 64 40**. And, if the delimiter is the default **&%** (hex 50 6C), then enter the commands as follows:

This is an &%1B26643044&%underlined&%1B266440&% word.

to print on the printer as:

This is an underlined word.

Notes: Only numbers or the upper case letters A F are allowed.

Errors in the Command Pass-Thru sequence will cause the interface to ignore the command and resume printing at the point the error occurred.

Command Pass-Thru may invalidate horizontal spacing.

Custom User Strings

Host download command 55 allows you to define up to six (0 through 5) custom user strings. A user string can be a font ID, a form feed, or another printer command that is frequently used. The information on page 3-28 describes how to define the custom user strings.

After the custom user string is defined, the string is activated by placing the delimiter (&% or the beginning delimiter defined with command 40), a capital letter U, and the number of the desired custom user string into the text of a document.

For example, use command 55 to define user string number 3 to send a form feed as follows (FF = 0C in hex):

&%Z55,3(0C)

ADVANCED FEATURES

Then, to send a form feed at the end of a print job, enter the following at the end of the document:

&%U3

Print the document, and the interface will send the 0C, or form feed, command to the printer when it encounters the &%U3 code.

SCS Mode Transparent Data

SCS transparent mode (SCS TRN code 35) provides a method for transparent data transmission when operating in LU1 mode. To use this method, you must be connected to a system using SNA protocol and be operating as a Logical Unit Type 1.

An SCS TRN sequence begins with a one-byte binary count immediately following the TRN code. The count indicates the number of bytes, not including the count byte, of transparent data to follow. Up to 256 bytes of transparent data can be sent in each sequence.

SCS TRN data is user-defined and is not scanned for SCS control codes. However, to emulate the characteristics of the IBM 3287, non-printable characters (i.e., control characters) are converted to hyphens. Data is translated to ASCII with undefined characters printed as hyphens. The I-O Print Box offers a configurable option to emulate the IBM 3287 or to pass the data without translation. Refer to command 45, SCS TRN translate, on page 3-26 for more detailed information.

Color Printing

The I-O Print Box allows printing of color on the HP Color LaserJet or DeskJet 1200C printers. Simply insert the I-O color command in front of the text you want to colorize. Return to the "normal" black color by inserting -C00. The I-O color commands are:

-C00 - Black	-C04 - Green
-C01 - Blue	-C05 - Turquoise/Cyan
-C02 - Red	-C06 - Yellow
-C03 - Magenta	-C07 - White
-C08 - Black	-C13 - Dark Turquoise

ADVANCED FEATURES

- C09 - Dark Blue
- C10 - Orange
- C11 - Purple
- C12 - Dark Green
- C14 - Mustard
- C15 - Grey
- C16 - Brown

For example, to print the word "red" in the color red in the following sentence, type:

This prints -C02red-C00 in red.

Printing Bar Codes

Using the I-O bar code feature, the following bar codes can be easily printed:

Type	Bar Code
1	Code 3 of 9
2	Code 128
3	Interleaved 2 of 5
4	POSTNET
5	UPC A
6	EAN 8
7	EAN 13

To print any of these bar codes, use the following format:

-B<type>,<height>,<width>,<hr>,<chkd>,<ast>,<data>-B

The bar code command string must contain all of these parameters, even if the parameter is irrelevant for the type of bar code being printed. For example, POSTNET comes in only one size, therefore, any height or width specifications are ignored.

-B Identifies the strings as a bar code command string. **-B** must be placed at the beginning and at the end of the string.

<type> Specifies the bar code type according to the table shown on the previous page.

ADVANCED FEATURES

<height> Specifies the height of the bar code. When using a PCL laser printer driver, height is expressed in multiples of 2.5 mm (approximately 1/10 inch). When operating in Epson or IBM Proprinter mode, height is expressed in multiples of 3.175 mm (1/8 inch). The height of the bar code can range from 1 (laser - 2.5 mm, dot-matrix - 3.175 mm) to 9 (laser - 22.5 mm, dot-matrix 28.575 mm) inclusive.

Height values are ignored if a POSTNET bar code is being printed, since POSTNET uses one standard height. However, a valid value (1-9) must be entered for the height parameter to ensure the bar code command string is complete.

<width> Specifies the width of a bar code module. A module is defined as a specific combination of bars and spaces used to represent a human readable character.

By changing the width parameter, you can determine the width of the module and the thickness of the bars and spaces.

Width parameters can range from 1 to 9 when printing to a PCL printer. When printing to an Epson or Proprinter mode dot-matrix printer, the width parameters can range from 1 to 3.

To determine the total length of the bar code, simply multiply the module length (found in the table on the following page) with the number of bar code characters.

Note: Be aware that the table gives rounded values only.

Example: Using Code 3 of 9, you want to bar code the word "PRINTERS." Assume the interface also generates a check digit and the start/stop characters. Setting the width parameter to 2 will yield a total bar code length of approximately 4 cm or about 1½ inches.

Number of characters: 11 (8 letters (PRINTERS) + 2 start/stop characters + 1 check digit)

ADVANCED FEATURES

Module width (from table below:) 3.6 mm (.14 inches)
 Calculation: 11 x 3.6 mm = 39.6 mm = 3.96 cm; or
 11 x .14 in = 1.54 inches

Module Width in mm (inches) - PCL Laser

Width	1	2	3	4	5	6	7	8	9
Code 3 of 9	2.6 (.1)	3.6 (.14)	4.5 (.18)	5.5 (.22)	6.5 (.25)	7.5 (.29)	8.4 (.33)	9.4 (.37)	10.4 (.41)
Code 128	2.2 (.09)	3.1 (.12)	3.9 (.15)	4.7 (.19)	5.6 (.22)	6.4 (.25)	7.3 (.29)	8.1 (.32)	8.9 (.35)
Interleaved 2 of 5	2.3 (.09)	3.2 (.12)	4 (.16)	4.9 (.19)	5.8 (.23)	6.6 (.26)	7.5 (.3)	8.4 (.33)	9.3 (.36)
Postnet	5.7 (.23)								
EAN-13	1.5 (.06)	2 (.08)	2.5 (.1)	3.1 (.12)	3.6 (.14)	4.2 (.16)	4.7 (.18)	5.2 (.20)	5.8 (.23)
EAN-8	1.7 (.07)	2.3 (.09)	2.9 (.11)	3.6 (.14)	4.2 (.16)	4.8 (.19)	5.4 (.21)	6.1 (.24)	6.7 (.26)
UPC A	1.6 (.06)	2.2 (.08)	2.8 (.11)	3.4 (.13)	4 (.16)	4.6 (.18)	5.2 (.2)	5.8 (.23)	6.4 (.25)

Module width in mm (inches) - Epson or IBM Proprinter Dot-Matrix

Width	1	2	3
Code 3 of 9	2.7 (.11)	5.4 (.22)	8.1 (.32)
Code 128	2.5 (.1)	5 (.2)	7.6 (.3)
Interleaved 2 of 5	2.2 (.9)	4.4 (.18)	6.6 (.26)
POSTNET	6.5 (.25)		
EAN 13	1.5 (.06)	3.1 (.12)	4.6 (.18)
EAN 8	1.8 (.07)	3.6 (.14)	5.5 (.21)
UPC A	1.8 (.07)	3.6 (.14)	5.5 (.21)

ADVANCED FEATURES

Width parameters are ignored when printing POSTNET bar codes, since POSTNET uses one standard width. However, a valid value (1-9) must be entered for the width parameter to ensure the bar code command string is complete.

<hr> Identifies whether human readables are printed or not. Human readables are printed underneath the bar code. Valid values are:

- 0 = Do not print human readables.
- 1 = Print human readables.

<chkd> Indicates whether the I-O interface automatically calculates and causes a check digit to be printed. The following bar codes **require** a check digit, therefore, the interface automatically generates and adds a check digit to the bar code data: Code 128, POSTNET, UPC A, EAN 8, EAN 13

If any of the bar codes listed above has been selected, the <chkd> selection is ignored by the interface. However, one of the following values must be entered to ensure the bar code command string is complete and valid. The options for the <chkd> parameter are:

- 0 = Do not calculate and add a check digit.
- 1 = Calculate and add a check digit to the bar code data.

<ast> Specifies whether start/stop characters are automatically generated or manually added. **This parameter only applies to bar code type Code 3 of 9.** For all other bar code types, the start/stop characters are automatically generated by the interface and input for the <ast> parameter is ignored. However, one of the following values must be entered to ensure the bar code command string is complete and valid.

The options for the <ast> parameter are:

- 0 = Do not automatically add start/stop characters.
- 1 = Automatically add start/stop characters.

ADVANCED FEATURES

Note: If value 0 is selected, you **must** manually enter start/stop characters (asterisks) together with the data. Failure to add the asterisks will cause an invalid bar code to be printed (i.e. a bar code without start/stop characters). If human readables are being printed, the asterisks will also print as human readables.

If value 1 is selected, you **must not** add asterisks as start/stop characters to the data. Failure to omit asterisks will cause an invalid bar code to be printed (i.e. a bar code with a start/stop character pair in the beginning and a start/stop character pair in the end.)

<data> The data to be printed as a bar code. Some bar codes require a certain number of characters. Others only allow alphanumeric or numeric characters. Before the I-O interface processes the data string, it will check the complete data string and verify that it is valid. This is why the `␣B` at the end is so important. If an invalid data string has been entered, the interface will print "Invalid Data" in the place of the bar code.

Notes:

1. Valid values must be entered for each of the parameters specified above, even if the parameter is irrelevant for the type of bar code being printed.
2. If an invalid parameter value (other than invalid data) has been entered, the interface will process the bar code command up to that point and then reject any information it receives after the incorrect value.

For example, a bar code command string has been entered, however, an invalid `<hr>` value of 3 has been specified.

```
␣B2,6,6,3,0,0,code128␣B
```

The interface would cause all characters after the invalid value 3 to be printed:

```
,0,0,code128
```

This helps quickly identify where the mistake occurred.

ADVANCED FEATURES

3. Spaces in the bar code command string are invalid and will lead to the same result as mentioned in Step 2.
4. If invalid data (either too many characters or the wrong type of characters) is entered, the interface will print the error message:
** Invalid Data **
5. Allow for sufficient vertical spacing when printing text data beneath the bar code.

For example, when the bar code command string is entered on line 1 of the document with a bar code height specified as 5 (approximately 1/2 inch or 3 lines at 6 LPI), and text is then entered on line 2 as follows,

```
-B5,7,1,0,0,0,1234567890-B  
This data overrun by barcode
```

this will cause the bar code to overlap the text in the second line:

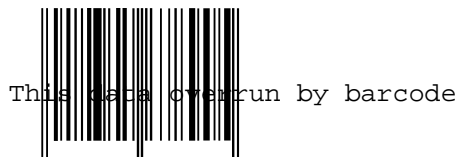

To avoid overlapping bar codes with text, always allow for sufficient vertical line spacing (e.g. line feeds) to accommodate the height of the bar code.

6. When printing on a laser printer, text may be entered to the right of the bar code command string. The text will appear immediately to the right of where the bar code print ends. When printing on a dot-matrix printer, the bar code command string must be the last item on a printed line. Any text placed directly behind the bar code string will not print correctly.

ADVANCED FEATURES

Overview and Examples

The following examples give an overview of the supported bar code types. Note that the "maximum number of data characters" does not include start/stop characters and check digits.

Code 3 of 9

Maximum number of data characters:	30
Valid numeric characters:	0-9
Valid alphanumeric characters:	A-Z
Valid other characters:	space ! " # \$ % & ' () + , - . / : ; < = > ? @

Example: -B1,4,1,1,1,1,0123456789-B



POSTNET

Maximum number of data characters:	30
Valid numeric characters:	0-9
Valid alphanumeric characters:	N/A
Valid other characters:	N/A

Example: -B4,1,1,1,1,0,0123456789-B



ADVANCED FEATURES

UPC A

Required number of data characters:	10
Valid numeric characters:	0-9
Valid alphanumeric characters:	N/A
Valid other characters:	N/A

Example: -B5,5,1,1,1,0,0123456789-B



EAN 8

Required number of data characters:	7
Valid numeric characters:	0-9
Valid alphanumeric characters:	N/A
Valid other characters:	N/A

Example: -B6,3,1,1,1,0,1234567-B



EAN 13

Required number of data characters:	12
Valid numeric characters:	0-9
Valid alphanumeric characters:	N/A
Valid other characters:	N/A

Example: -B7,3,1,1,1,0,012345678912-B



ADVANCED FEATURES

Interleaved 2 of 5

Maximum number of data characters:	30
Valid numeric characters:	0-9
Valid alphanumeric characters:	N/A
Valid other characters:	N/A

Example: ~B3,3,1,1,1,0,0123456789~B



Note: Since Interleaved 2 of 5 symbols are created from data character pairs, the number to be encoded must have an even number of digits. If an odd number of data characters (including the optional check digit) is entered, the interface adds an "0" to the beginning of the bar code. If an even number of data characters (including the optional check digit) is entered, the interface prints the bar code exactly as it is input.

Code 128

Code 128 has three unique character subsets (code A, B, and C) shown in the table on the following pages. When entering data representing Code 128 bar code, follow these two steps:

1. Define which code set you want to use. For example, type "A" to represent code A; type "B" to represent Code B; and type "C" to represent code C.
2. If you are using code set B, enter the data characters directly. The ~ character and other special characters are represented by the Symbol Character Value found in the left column of the table on the following pages.

If you are using code set A or C, enter the Symbol Character Value found in the left column of the table. Each character is represented by

ADVANCED FEATURES

two digits or a ~ followed by a digit. For example, to bar code the character "&" using Code Set A, type 06.

Maximum number of data characters: 30 (includes special characters)
 Valid characters: Differs with selected code set, see table on following pages



Example: ~B2,3,2,1,1,0,ABCDEFGHIJKLMNOPQRSTUVWXYZ~B

To show how multiple character sets are used, study the following data string. Height, width and other parameters were omitted in this example to focus your attention on the data string. Please note that this example is for illustration purposes only, and is not a recommended way of bar coding. The following data string is a fairly complex way of bar coding "10PrintBoxes10".

~B2,....,A1716~6PrintBoxes~510~B

A: selects code set A
 17: selects the number 1 from code set A
 16: selects the number 0 from code set A
 ~6: switches from code set A to code set B
 PrintBoxes: selects the characters PrintBoxes from code set B
 ~5: switches from code set B to code set C
 10: selects the number 10 from code set C

Symbol Character Value	Data Character		
	Code A	Code B	Code C
00	SP	SP	00
01	!	!	01
02	"	"	02
03	#	#	03
04	\$	\$	04
05	%	%	05
06	&	&	06
07	'	'	07

ADVANCED FEATURES

Symbol Character Value	Code A	Data Character Code B	Code C
08	((08
09))	09
10	*	*	10
11	+	+	11
12	,	,	12
13	-	-	13
14	.	.	14
15	/	/	15
16	0	0	16
17	1	1	17
18	2	2	18
19	3	3	19
20	4	4	20
21	5	5	21
22	6	6	22
23	7	7	23
24	8	8	24
25	9	9	25
26	:	:	26
27	;	;	27
28	<	<	28
29	=	=	29
30	>	>	30
31	?	?	31
32	@	@	32
33	A	A	33
34	B	B	34
35	C	C	35
36	D	D	36
37	E	E	37
38	F	F	38
39	G	G	39
40	H	H	40
41	I	I	41
42	J	J	42
43	K	K	43
44	L	L	44
45	M	M	45

ADVANCED FEATURES

Symbol Character Value	Code A	Data Character Code B	Code C
46	N	N	46
47	O	O	47
48	P	P	48
49	Q	Q	49
50	R	R	50
51	S	S	51
52	T	T	52
53	U	U	53
54	V	V	54
55	W	W	55
56	X	X	56
57	Y	Y	57
58	Z	Z	58
59	[[59
60	\	\	60
61]]	61
62	^	^	62
63	_	_	63
64	NUL	`	64
65	SOH	a	65
66	STX	b	66
67	ETX	c	67
68	EOT	d	8
69	ENQ	e	69
70	ACK	f	70
71	BEL	g	71
72	BS	h	72
73	HT	i	73
74	LF	j	74
75	VT	k	75
76	FF	l	76
77	CR	m	77
78	So	n	78
79	S	o	79
80	DLE	p	80
81	DC1	q	81
82	DC2	r	82
83	DC3	s	83

ADVANCED FEATURES

Symbol Character Value	Code A	Data Character Code B	Code C
84	DC4	t	84
85	NAK	u	85
86	SYN	v	86
87	ETB	w	87
88	CAN	x	88
89	EM	y	89
90	SUB	z	90
91	ESC	{	91
92	FS		92
93	GS	}	93
~0	RS	~	94
~1	US	DEL	95
~2	FNC3	FNC3	96
~3	FNC2	FNC2	97
~4	SHIFT	SHIFT	98
~5	CODE C	CODE C	99
~6	CODE B	FNC4	CODE B
~7	FNC4	CODE A	CODE A
~8	FNC1	FNC1	FNC1

I-O Graphics Language™

The I-O Graphics Language™ (IOGL™) allows printing of graphical elements and charts. IOGL is independent of other I-O features, such as internally generated bar codes or font change commands. This means that if an I-O font change command is followed by a IOGL command to rotate text, the text would print in the specified font. IOGL is also independent of regular text data. This allows text data to be overlaid by a graphical element, such as a shaded box.

On the IBM 3270-type mainframe host, IOGL graphics can only be generated using the LU1 data stream.

ADVANCED FEATURES

I-O Graphics Language™ Overview

The table on the following pages is an overview of the I-O Graphics Language™ (IOGL) command strings and a brief description of the parameters used in the IOGL strings.

Graphical Element	IOGL Command String
Line	¬GL<line width>;<x start>;<y start>;<x end>;<y end>
Box	¬GB<line width>;<x start>;<y start>;<x end>;<y end>;<% shading>
Circles	¬GC<line width>;<x center>;<y center>;<radius>;<% shading>
Arc	¬GA<line width>;<x start>;<y start>;<x center>;<y center>;<angle of rotation>
Shading/Color	¬GS<# of values>;<color 1>;<% shading 1>;<color 2>;<% shading 2>;. . .
Pie Chart	¬GP<line width>;<x center>;<y center>;<radius>;<# of segments>;<segment value 1>;<segment value 2>;. . .
Bar Chart (Histogram)	¬GH<line width>;<x start>;<y start>;<x increment>;<y increment>;<bar width>;<# of entries>;<value 1>;<value 2>;. . .
Run (Line) Chart	¬GR<line width>;<x start>;<y start>;<x increment>;<y increment>;<# of entries>;<value 1>;<value 2>;. . .
Text Rotation	¬GT<x start>;<y start>;<angle of rotation>;<'text'>
Comments	¬GX<'text'>

ADVANCED FEATURES

Parameter	Description	Units of Measurement	Valid Values
'text'	text to be rotated or to be included in the IOGL program as a comment	N/A	any printable character
% shading	percentage of shading	percentage	0-100, integers
# of segments	number of segments to be printed in pie chart	each	1 to 9, integers
# of entries	number of values to be printed in bar or run (line) chart	each	1 to 12, integers
angle of rotation	angle of rotation of arc or text	degrees	arc: 0 to 360, integers text: 0, 90, 180, 270
bar width	width of a bar in a bar chart	n/300 inch	positive integers
color n	I-O color code to select color of pie or bar chart segments	I-O color command numbers	00 to 16
line width	width of any printed line (in line, box, arc, circle, chart)	mm	any positive number
radius	radius of a circle or pie chart	n/300 inch	positive integers
segment value n	value to be represented by a pie chart segment	integer	0 to 100

ADVANCED FEATURES

Parameter	Description	Units of Measurement	Valid Values
value n	a value to be represented by a bar in a bar chart or a point in a line chart	any positive integer	any positive integer
x start	x coordinate of start position for lines and boxes	n/300 inch	positive integers; incl. 0
x end	x coordinate of end position for lines and boxes	n/300 inch	positive integers; incl. 0
x center	x coordinate of center point of circle, arc, or pie chart	n/300 inch	positive integers; incl. 0
x increment	horizontal movement before next bar (bar chart) or value (run chart) is printed	n/300 inch	positive integers; incl. 0
y center	y coordinate of center point of circle, arc, or pie chart	n/300 inch	positive integers; incl. 0
y start	y coordinate of start position for lines and boxes	n/300 inch	positive integers; incl. 0
y end	y coordinate of end position for lines and boxes	n/300 inch	positive integers; incl. 0
y increment	height of one unit of the value to be printed in bar or run (line) chart	n/300 inch	positive integers; incl. 0

ADVANCED FEATURES

Helpful Hints

1. All xy values (start, end, center, increment) are measured in n/300 of an inch. The origin of the xy coordinate system is the top left hand corner of the printable area of the page (see Figure 1).

The printable area of the page may vary with the printer model and paper size being used. Refer to your printer's user's guide for specific information.

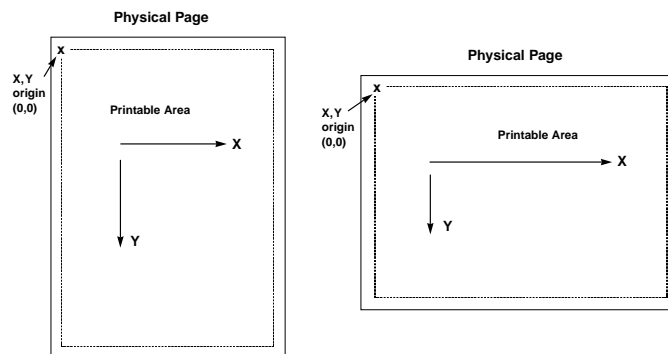

Figure 1

2. The complete command string must be entered as shown below. Incomplete command strings and command strings with invalid values (such as spaces) will cause the interface to print the string at the place the error occurred.

For example, a line command string has been entered. However, an invalid <x start> value has been specified.

```
-GL30;A;1;1;600
```

The interface would cause all characters, including the invalid value "A" to be printed:

```
A;1;1;600
```

ADVANCED FEATURES

3. As an alternative to using the semi-colon ";" as a separator between parameters, you may also enter a comma "," or a forward slash "/".
4. Do not enter numeric values with commas (i.e. 50,000). The printer interface will interpret the ",", " to be the end of the parameter (i.e. 50,000 would be interpreted as two values: value 1 = 50, value 2 = 000).

International users should also be aware that a decimal value used to specify line width (in mm) such as "1,5" (i.e. 1 1/2) is also interpreted as two separate values (i.e. value 1 = 1, value 2 = 5). To enter a valid decimal line width use the period "." (i.e. 1.5 mm).

Basic Description

Lines --GL<line width>;<x start>;<y start>;<x end>;<y end>

Draws a line from the specified xy start to xy end. <Line width> is specified in mm.

For example: **-GL2;100;0;100;600** draws a 2 mm wide, vertical (<x start> = <x end>) line of 2 inches in length (<y-end> - <y-start> = 600/300" = 2") (Figure 2)

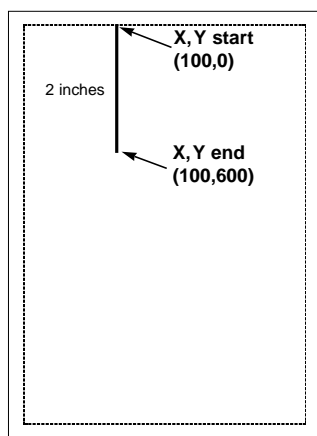

Figure 2

ADVANCED FEATURES

Boxes - `-GB<line width>;<x start>;<y start>;<x end>;<y end>;<% shading>`

Draws a box from the specified xy start to the xy end. The box cannot be rotated. <line width> is specified in mm, <% shading> can range from 0 to 100.

For example: `-GB2;300;300;600;600;30` draws a box with 2 mm wide border and 30% shading (Figure 3)

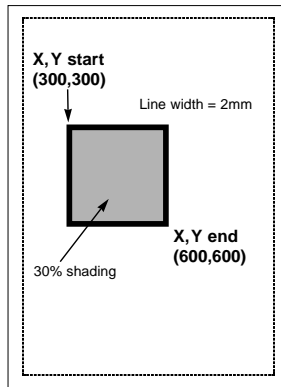

Figure 3

Circle - `-GC<line width>;<x center>;<y center>;<radius>;<% shading>`

Draws a circle with the specified radius (in n/300 inches) and line width (in mm) around the xy center.

ADVANCED FEATURES

For example: `¬GC2;900;2400;300;70` draws a circle with a radius of 1 inch (300/300 inches) (Figure 4)

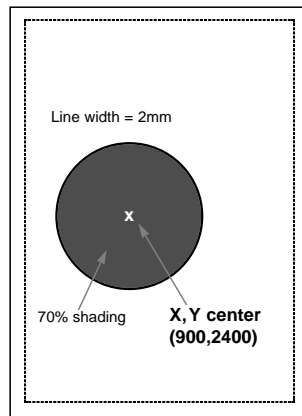

Figure 4

Note: To avoid cutting of part of the circle, make sure that the radius and the x,y center values are such that the complete circle will fit into the printable area of the page.

Arc - `¬GA<line width>;<x start>;<y start>;<x center>;<y center>;<angle of rotation>`

Draws an arc around the xy center, starting at xy start and ending when the angle of rotation is completed. (Angle is measured from theoretical line xy center to xy start and rotates clockwise.)

ADVANCED FEATURES

For example: `GA1;500;900;900;180` draws an arc (semi-circle since rotation is 180 degrees) (Figure 5)

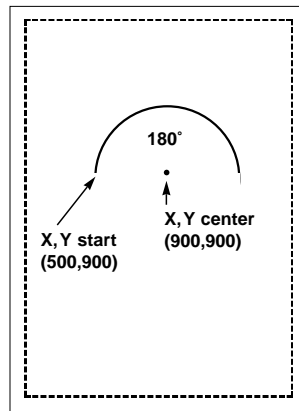

Figure 5

Color/Shading- `GS<# of values>;<color 1>;<% shading 1>;<color 2>;<% shading 2>;...`

Defines the color and shading of the pie chart and bar chart segments. The first value entered in the pie and bar chart commands will be printed in color 1 with shading 1. The second value entered in the pie and bar chart commands will be printed in color 2 with shading 2.

Colors are entered as numeric values 0-16 (corresponding to I-O color command scheme). Shading is entered as a numeric value from 0-100 (% of shading). If the attached printer is not capable of recognizing PCL color commands, all printing will be black. Refer to pie and bar charts for an example.

ADVANCED FEATURES

Pie Chart - `-GP<line width>; <x center>;<y center>;<radius>;<# of segments>;<segment value 1>;<segment value 2>;...`

Draws a pie chart around the xy center with the specified radius (in n/300 inches), number of segments (maximum of 9), and segment values. Segment values are entered as numeric and converted to percentages. Segment values can range from 0 to 100.

Each segment will have the color and/or shading as specified in the shading command (pie chart value 1 will get color/shading value 1,...). `<line width>` is specified in mm. The first pie segment starts at "9 o'clock", meaning on the far left of the circle (Figure 6a).

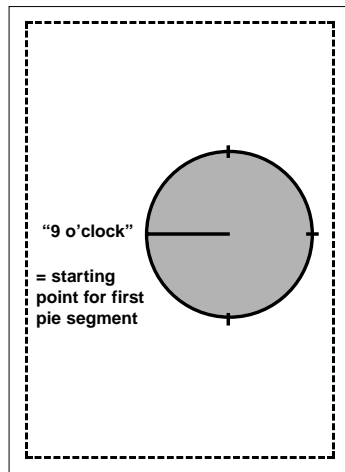

Figure 6a

ADVANCED FEATURES

For example: `-GS3;01;20;02;50;04;80 -GP5;900;2400;600;3;10;20;30` draws a three-segment pie chart. If the attached printer is a PCL color printer, the first segment will be blue (01), the second segment will be red(02), and the third segment will be green (04). The segments will be shaded at 20%, 50%, and 80% respectively. The first segment (value 10) will be 1/6 of the complete circle ($10/(10+20+30)=10/60=1/6$), the second segment (value 20) will be 2/6 of the complete circle ($20/60$), and the third segment will be 3/6 of the complete circle (Figure 6b).

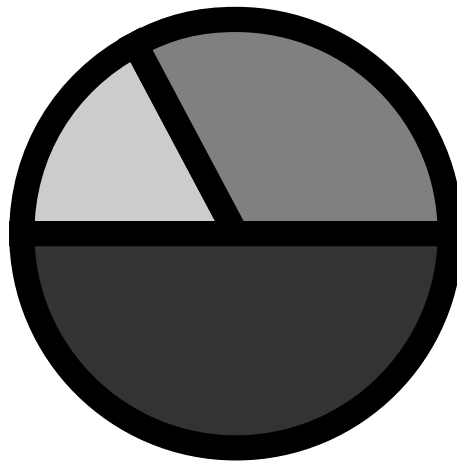

Figure 6b

Bar Chart (Histogram) - `-GH<line width>;<x start>;<y start>;<x increment>;<y increment>;<bar width>;<# of entries>; <value 1>;<value 2>; ...`

Draws a bar chart. `xy start` specifies the bottom left hand corner of the first bar (the origin on the chart's `xy`-scale). The `x increment` specifies the horizontal movement before the next bar is printed. The `y increment` (in $n/300$ inches) determines the height of the bar (multiplied by the value). The `bar width` (in $n/300$ inches) specifies the width of the bar.

Bar chart values can range from 0 to 3,000. Each bar will have the color and/or shading as specified in the shading command (bar 1 is color/shading value 1,...). A maximum of 12 bars can be printed.

ADVANCED FEATURES

For example: **-GS3;01;20;02;50;04;80**
-GH1;100;2400;300;1;100;3;500;600;800 draws three bars. If the attached printer is a PCL color printer, the first bar will be blue, the second red, and the third green. The bars will be shaded 20%, 50%, and 80% respectively (Figure 7).

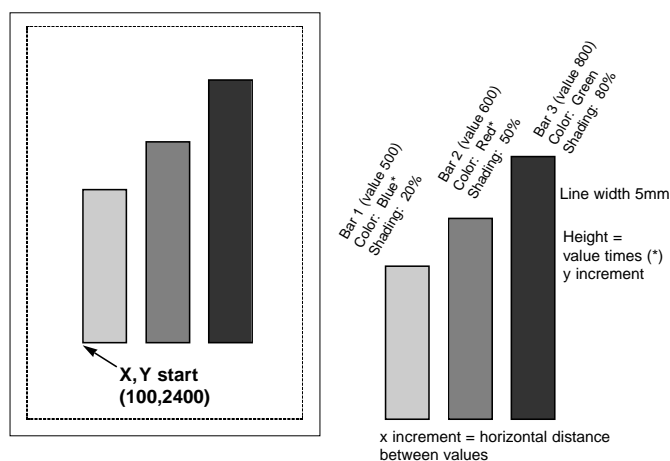

Figure 7

Each bar is 1/3 inch wide (100/300 inch). The distance from the left side of one bar to the left side of the next bar is one inch (300/300). This allows other bars to be added through a separate command.

Bar 1 will be 1 2/3 inches (500 x 1/300 inch) high, bar 2 will be two inches high (600 x 1/300 inch), and bar 3 will be 2 2/3 inches high (800 x 1/300 inch).

Note: The y-increment determines the scaling. Only integers (i.e. 1, 2, 3, 4, etc.) are valid. If you are charting sales figures in thousands of dollars, the y-increment should be small (for example, 1). If you are charting the number of customer complaints per period the y-increment should be high (for example, 100 or more). Be aware that the bar height must not exceed the total printable area of the page.

Run Chart - **-GR**<line width>;<x start>;<y start>;<x increment>;<y increment>;<# of entries>;<value 1>;<value 2>; ...

ADVANCED FEATURES

Draws a run (line) chart. The xy start specifies the origin of the chart's xy scale (xy axes are not drawn). The x increment specifies the horizontal movement before the next value is printed. The y increment determines the height of the line (multiplied by the value).

For example: `-GR3;900;2400;150;1;5;100;300;200;500;400` draws a run (line) chart (Figure 8).

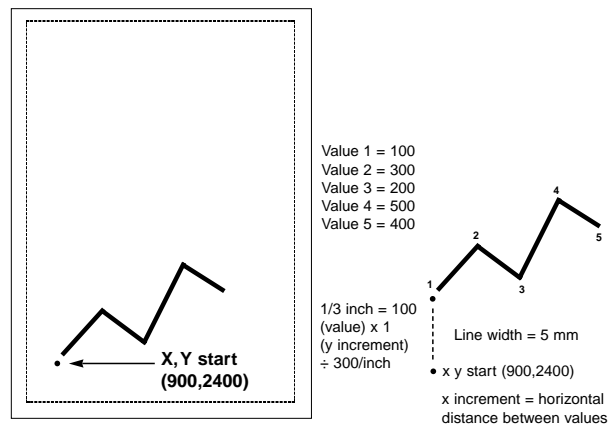

Figure 8

Note: The y-increment determines the scaling. Only integers (i.e. 1, 2, 3, 4, etc.) are valid. If you are charting sales figures in thousands of dollars, the y-increment should be small (for example, 1). If you are charting the number of customer complaints per period the y-increment should be high (for example, 100 or more).

Text - `-GT<x start>;<y start>;<angle of rotation>;<'text'>`

Prints the text ('text') in the active font, with the specified rotation and specified xy start. Text will be rotated counter clockwise.

ADVANCED FEATURES

For example: `-GT1000;1000;90;TEXT` prints the word "TEXT" in the active font with 90 degree rotation (Figure 9).

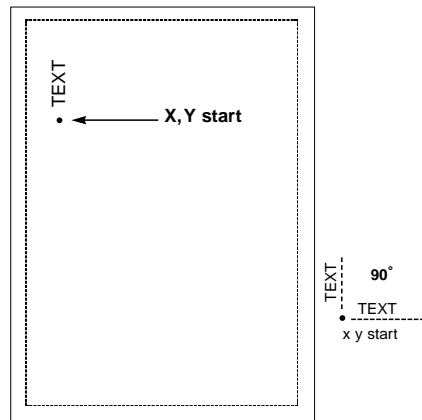

Figure 9

Comments - `-GX<text>`

Allows text to be added to IOGL commands for documentation. Comments will not print out.

For example: `-GX'Pie chart with 3 elements'` can be used to document an IOGL pie chart command.

I-O Graphic Language™ (IOGL) in Action

General Steps

I-O Graphics Language™ (IOGL) can be used in many different ways. It can enhance the appearance of standard host reports through a few simple graphical elements such as lines, boxes, and circles; or it can be used to present pertinent data through charts. IOGL can even be used to create sophisticated electronic forms. However, to utilize IOGL all applications have the following in common:

ADVANCED FEATURES

1. Determine which IOGL elements are needed to create the desired output (i.e. the bar chart shown below uses four different IOGL elements).
2. Determine the printable area of the page.
3. Determine the positioning of the graphical elements relative to the top left hand corner of the printable area.
4. **PCL color printer only.** Determine the order in which to print the graphical elements. The lines of the last IOGL element will overlap (and cover) the previous IOGL elements.
5. Design the graphical output, one element at a time.
6. Link the graphical output with your host application.

Tutorial

The following example (Figure 10) shows how multiple IOGL elements interact to create a bar chart.

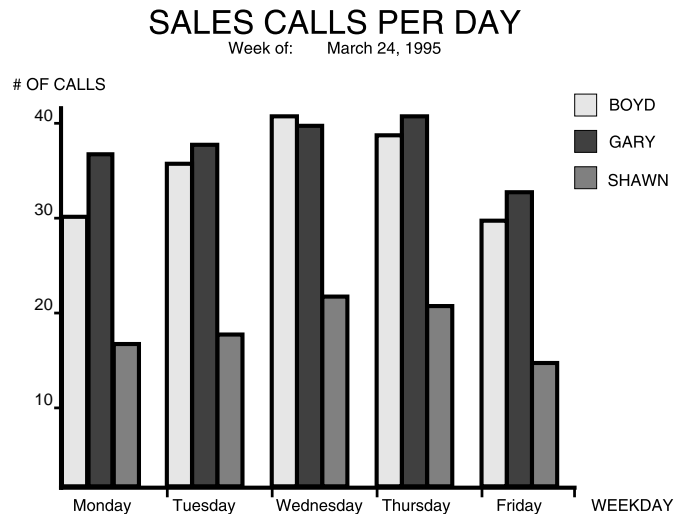

Figure 10

ADVANCED FEATURES

1. Following the above mentioned general steps, we first determined the makeup of this bar chart. The example consists of four IOGL elements: bar charts, lines, boxes, and text.
2. To determine the printable area of the paper, we printed a box using 0;0 as the x;y -start coordinates. This was done by typing `-GB1;0;0;300;300;50` on the screen and sending it to the printer. The top left corner of the printed box marks the top left corner of the printable area of the page. For reference, we drew the printable area on the blank sheet of paper. All references to distances are made in respect to the printable page, not the actual physical page. Refer to Figure 1 on page 5-20.
3. Determine where the chart should be placed (always in relation to the top left hand corner of the printable area). In the example, the bar chart is on the bottom half of a letter size page. The origin of the chart is one inch away from the left margin and 10 inches away from the top margin (Figure 11).

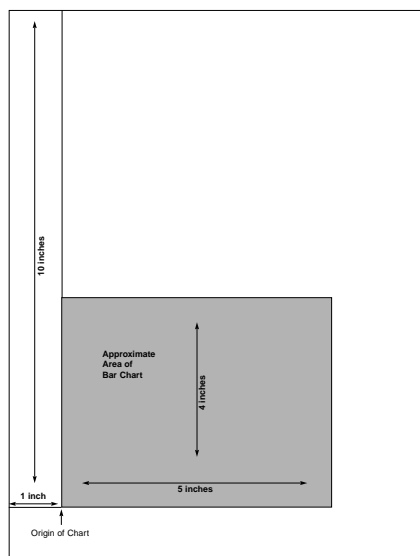

Figure 11

ADVANCED FEATURES

Next, determine the approximate maximum height and width of the chart. In the example, 40 was the expected maximum number of calls. We chose to represent 10 calls by one inch, resulting in a total maximum height of four inches (not including the title and subtitle.) Similarly, each day was represented by one inch, resulting in a total maximum width of five inches (not including the space needed for the label "WEEKDAY").

4. If the chart is being printed on a black and white PCL printer, the order in which these elements are created is irrelevant. However, if you are printing on a PCL color printer, the lines of the last element will always overlay (and cover) the element previously printed. In the example, the elements creating the x and y-axes should be entered last when printing on a PCL color printer.
5. Create the separate IOGL elements based on the order determined in Step 4. In the example, the bar charts were created first. Recall the IOGL formula for the bar chart and the preceding shading/color command string:

```
-GS<# of values>;<color 1>;<% shading 1>;<color 2>;<% shading 2>;...
```

```
-GH<line width>;<x start>;<y start>;<x increment>;<y increment>;<bar width>;<# of entries>;<value 1>;<value 2>; ...
```

The bar chart shown on page 5-30 was created using the following parameters:

Bar Chart Boyd

Shading/Color: Boyd's calls were plotted for each day of the business week, so the number of values is five. Since we printed to a black and white laser printer, the color parameters were irrelevant. The shading was set to 10%.

Bar Chart (Histogram): The **line width** was set to 1 mm. The **x;y-start** parameters defined the bottom left corner of the bar which is identical with the origin of the chart. Remember that the origin was one inch from the left margin, and 10 inches from the top margin of the printable area. The resulting values were 300 (=1 inch x 300/inch) for <x start> and 3000 (= 10 inches x 300/inch) for <y start.>.

ADVANCED FEATURES

The bar representing Boyd's calls for Tuesday was to be printed one inch to the right of Monday's bar. The resulting **<x increment>** was 300 (= 1 inch x 300/inch). Since the maximum height of a bar was specified at four inches, the resulting value for **<y increment>** was 30 (= 4 inches/40 max. calls x 300/inch).

To aid in readability, extra space was left between the last bar of day one and the first bar of the next day. To determine the **<bar width>** divide the available one inch (**<x increment>**) into four equal sections (three bars and one space). The resulting value was 75 (= 300/4). Next, count the **<# of entries>** (5) and enter the respective values. The parameters are:

```
-GX'bar chart Boyd'  
-GS5;01;10;01;10;01;10;01;10;01;10  
-GH1;300;3000;300;30;75;5;30;34;39;37;28
```

Bar Chart Gary

The bars representing Gary's calls were to be printed directly to the right of Boyd's. The resulting horizontal start value **<x start>** was:

$$\begin{array}{r} 300 \quad (\text{Boyd's}) \\ + 75 \quad (\text{Bar width}) \\ \hline 375 \end{array}$$

With the exception of the actual calls, the other parameters for Gary's bar chart were identical to Boyd's. The parameters are:

```
-GX'bar chart Gary'  
-GS5;02;75;02;75;02;75;02;75;02;75  
-GH1;375;3000;300;30;75;5;35;36;38;39;31
```

ADVANCED FEATURES

Bar Chart Shawn

Shawn's bar chart was to be printed directly to the right of Gary's. The resulting horizontal starting position <x start> was:

$$\begin{array}{r} 375 \text{ (Gary's)} \\ + 75 \text{ (Bar width)} \\ \hline 450 \end{array}$$

The parameters are:

```
-GX'bar chart Shawn'  
-GS5;04;50;04;50;04;50;04;50;04;50  
-GH1;450;3000;300;30;75;5;15;16;21;20;13
```

X and Y-Axes

The x-axis (Weekday) and the y-axis (# of calls), along with the increments, were created through a series of separate lines. Notice that the line width of the axis is the same as the line width of the bars. The parameters are shown below:

```
-GX'X-Axis with increments'  
-GL1;300;3000;1850;3000  
-GL.5;600;3000;600;3019  
-GL.5;900;3000;900;3019  
-GL.5;1200;3000;1200;3019  
-GL.5;1500;3000;1500;3019  
-GL.5;1800;3000;1800;3019  
  
-GC'Y-Axis with increments'  
-GL1;300;3000;300;1750  
-GL.5;281;2700;300;2700  
-GL.5;281;2400;300;2400  
-GL.5;281;2100;300;2100  
-GL.5;281;1800;300;1800
```

ADVANCED FEATURES

Labels/Title/Subtitle/Legend

All text was created through text rotation command strings. Text was always printed in the selected font. In the example, Universe Medium was used in different point sizes (–Q...). The legend consists of three separate boxes followed by text rotation commands. The parameters are shown below:

```
–GX'Font Change Command' –Q4808
–GX'Labels X-Axis'
–GT300;3100;0;'Monday'
–GT600;3100;0;'Tuesday'
–GT900;3100;0;'Wednesday'
–GT1200;3100;0;'Thursday'
–GT1500;3100;0;'Friday'
–GT1800;3100;0;'WEEKDAY'

–GX'Labels Y-Axis' –GT200;2700;0;'10'
–GT200;2400;0;'20'
–GT200;2100;0;'30'
–GT200;1800;0;'40'

–GX'Legend (boxes with text)' –GT200;1650;0;'# OF CALLS'
–GB1;1700;1650;1750;1700;10
–GT1760;1700;0;' = BOYD'
–GB1;1700;1750;1750;1800;75
–GT1760;1800;0;' = GARY'
–GB1;1700;1850;1750;1900;50
–GT1760;1900;0;' = SHAWN'

–GX;Font Change Command' –Q4813
–GX'Title'
–GT500;1500;0;'SALES CALLS PER DAY'

–GX'Font Change Command' –Q4808
–GX'Subtitle'
–GT600;1550;0;'Week of:'
–GT900;1550;0;'March 24, 1995'
```

ADVANCED FEATURES

Linking Graphical Output to a Host Application

There are several ways to link the graphical output to a host application. One method is to simply add the IOGL commands to the application code. This means that whenever the application is used and sent to the printer, the IOGL commands are also sent.

Another method is to design a separate subroutine that sends the IOGL output to the printer as a macro. The IOGL macro will only be sent to the printer once and resides in the printer's active memory until the printer is powered down. The application code requires only a macro call and does not require the complete graphic to be downloaded when a report is printed.

To store the IOGL output as a printer macro, begin the IOGL routine with a PCL command that begins a macro by typing: **~E&f#y0X**

Substitute the # symbol with a number that identifies the macro. Make sure this command precedes all IOGL commands. Also, be aware that PCL is case sensitive.

At the end of the IOGL routine, stop the macro and save it permanently (until the printer is powered down) in the printer's memory. To end the macro type: **~E&f#y1X**

To save the macro permanently (until the printer is powered down) type: **~E&f#y10X**. Store this macro in the printer's memory by "printing it."

A call for this macro can be used in your application by embedding the following PCL command in the application code: **~E&f#y3X**

Another command that can be used to prevent overloading the printer's memory is **~E&f#y8X**. This command deletes the macro ID # that currently resides in the printer's memory.

ADVANCED FEATURES

Printing Images From The Host

It is often advantageous to include images such as company logos or signatures with printed output. Logos and other images can be stored on printer cartridges or "Flash" SIMMs. These products are offered through the printer manufacturer and/or various third party vendors. While the process of loading the cartridge or SIMM differs, the final result is the same. The stored image is assigned a macro ID number that must be called up by the application when the image is to be printed. Please refer to the documentation supplied with the cartridge or SIMM for instructions on how to store an image.

Generally, a macro stored in non-volatile memory is called up by sending the command **~E&f#y3X** where # is the macro ID.

A PCL command used to reposition the stored image on a page is **~E&l#u#Z** where the first # (l#u) specifies the "Left Offset Registration" or horizontal movement in n/720 inch and the second # (#Z) specifies the "Top Offset Registration" or vertical movement of the image in n/720 inch.

The repositioning command must precede the macro call. To return to the original position, type **~E&10u0Z** immediately after the macro call.

ADVANCED FEATURES

This page left intentionally blank.

6 PROBLEM RESOLUTION

This chapter provides instructions for performing diagnostic tests on the I-O Print Box. This chapter also contains a problem resolution guide that describes common problems with the interface or the printer and their solutions. If you are unable to solve a problem by following the procedures outlined in this chapter, contact your I-O dealer or I-O Customer Support.

Before calling, verify that the I-O Print Box is installed correctly, that the interface configuration settings are correct, perform the appropriate diagnostic tests outlined in this chapter, and have the following information ready:

- Printer and interface self-test printouts
- Model number and serial number of the interface
- Description of the problem
- Results of diagnostic tests
- Type of host system or controller

You may also need to print a "hex dump" or "buffer print" by enabling the Buffer Print option through the interface's configuration switches, or Host/PC download command 42. This causes all printing to be in hexadecimal code, just as it's received from the host, to help in tracing problems.

If it becomes necessary to ship the interface, use the original carton and packaging to prevent damage.

Interface Self-Test

Verify proper installation and configuration of the interface by performing an interface self-test. The self-test prints out the current software version, memory condition (RAM and ROM), and the current configuration selections.

PROBLEM RESOLUTION

Note: If you are operating a label printer, put the printer in ASCII hex dump mode, then follow the self-test instructions below. If the label printer starts printing the interface has passed the self-test. To obtain a printout of the current settings, connect the interface to a laser or dot-matrix printer.

Follow the steps below to start the self-test from your PC or terminal.

1. Verify that the printer is connected properly to the interface and in "READY" mode.
2. Type "&%Z98,1" on the screen.
3. Send the Host/PC download command to the printer (i.e., press the Print Screen Button or print the document/file that contains the Host/PC download command). The self-test will print out in a few seconds.

Follow the steps below to start the self-test by setting the configuration switches.

1. Verify that the printer is connected properly to the interface.
2. Power off the printer interface and the printer.
3. Set configuration switch SW1:8 (far right of first switch bank) to "|" and configuration switch SW1:1 to "o".
4. Power on the printer and the interface. A self-test will print within a few seconds after power up. After the self-test prints, the LED lights labeled "Host Ready" and "Printer Ready" begin blinking, indicating that the Print Box is not in operating mode.
5. Return configuration switch SW1:8 to the "o" position, then cycle the power one more time.

Two self-test pages will print if the interface is installed properly. Sample printouts of the first page are shown on pages 2-5 through 2-8. The selections in the sample are factory defaults. The numbers at the left margin are command numbers used to change this setting using host download commands (see page 3-4).

PROBLEM RESOLUTION

If the test does not print, the interface failed the self-test. Contact your I-O Dealer or I-O Customer Support for more information.

EBCDIC Hex Dump

The interface can be set up to print the buffer in hexadecimal EBCDIC code. This can be useful for a technician to diagnose problems with the interface or the printer.

The EBCDIC hex data is printed on a grid corresponding to the data's position in the buffer. If the hex data represents a printable character, that character is printed below the hex data.

To start the EBCDIC hex dump through Host/PC Download:

1. Verify that the printer is connected properly to the interface.
2. Type "&%Z42,1" on the screen.
3. Send the Host/PC download command to the printer (press the Print Screen Button or print the document/file that contains the Host/PC download command).
4. Send the host data in question to the printer.
5. To stop the EBCDIC hex dump, type "&%Z42,2" on the screen.
6. Send the Host/PC download command to the printer (press the Print Screen Button or print the document/file that contains the Host/PC download command).

Start the EBCDIC hex dump from the interface's front panel as follows:

1. With the interface powered on, set configuration switch SW1:1 (far left) to "o", and switch SW1:8 (far right of first switch bank) to "|". The interface is now in buffer print mode.
2. Return configuration switch SW1:8 to the "o" position after printing is completed.

PROBLEM RESOLUTION

ASCII Hex Dump

The interface can be set up to print the buffer in hexadecimal ASCII code. This differs from the EBCDIC hex dump in that the buffer is first translated into ASCII code before it is printed. This can be useful to diagnose problems with the interface or the printer. The ASCII Hex Dump can only be started through the interface's configuration switches. To start the ASCII Hex Dump:

1. Locate configuration switches SW1:4, SW1:5, SW1:6, and SW1:7 on the first switch bank.
2. Write down their current position ("o" or "|").
3. With the Print Box powered on, set the configuration switches SW1:4, SW1:5, SW1:6, and SW1:7 to "|". The interface is now in ASCII Hex Dump mode.
4. To end ASCII Hex Dump mode, return the switches to their original position (see Step 2).

Problem Resolution Guide

The following is a general guide to resolve common problems that may occur. Please refer to this guide before contacting I-O Customer Support.

PROBLEM RESOLUTION

Problem or Message	Probable Cause	Action
“Host Ready” LED is not on when connected to the host	Host is not operating	Check host system
	Damaged or improper cabling	Check host cabling for damage or improper connection
“Printer Ready” LED is off when printer is connected	Printer not in a ready status	Make sure printer is on line, has paper, etc.
	Printer fault such as paper out, paper jam, etc.	Make sure the printer has paper, is clear of jams, etc.
	Damaged or loose printer cable	Check printer cable for damage or improper connection
Printer loses host communication (drops off line)	Improper or damaged cabling	Check host cabling for improper connections or damage
Right margin is cut off	Page width in word processing program is not set wide enough	Change to a wider page
	Page width is too wide	Select a narrower page
Extra blank sheets are ejected between sheets of printout	Form length not correct in software (maximum length is 66 lines)	Make sure your document length doesn't exceed the maximum number of lines.
	Page orientation was changed	The printer may eject a blank page when the page orientation (portrait or landscape) is changed

PROBLEM RESOLUTION

Problem or Message	Probable Cause	Action
Form length is incorrect	Form length incorrect in software	Change form length
Printer won't change fonts	Incorrect typestyle number	Make sure the font ID used is valid. Invalid font IDs are ignored by the printer
	Wrong font cartridge loaded	Load the cartridge with the font that corresponds to the font ID
	Font cartridge damaged or not seated into the printer properly	If possible try a known good cartridge to determine if cartridge is faulty. Make sure the cartridge is loaded properly
Printer does not print landscape in requested font	APO feature is <u>ON</u> and page size is 8 1/2" x 11" or less; and width is less than height	Turn off APO <u>or</u> increase page size so it is larger than 8 1/2" x 11" <u>or</u> change width and height so width is greater than height
	APO feature is <u>OFF</u> and orientation is set to COR, portrait, or user-defined (with font orientation portrait)	Set paper tray orientation to landscape <u>or</u> set font orientation to landscape

PROBLEM RESOLUTION

Problem or Message	Probable Cause	Action
Printer does not print portrait in requested font	APO feature is ON <u>and</u> page size is 8 1/2" x 11" or less; <u>and</u> width is greater than height	Turn off APO <u>or</u> increase page size so it is larger than 8 1/2" x 11" <u>or</u> change width and height so width is less than height. Refer to the COR and APO sections, pages 4-4 and 4-6, for additional solutions
	APO feature is OFF <u>and</u> orientation is set to COR, landscape, or user defined (with font orientation landscape)	Set paper tray orientation to portrait <u>or</u> set font orientation to portrait
Printer does not print COR	APO feature is ON <u>and</u> page size is 8 1/2" x 11" or less	Turn off APO <u>or</u> increase page size so it is larger than 8 1/2" x 11"
	APO feature is OFF <u>and</u> orientation is set to portrait, landscape, or user-defined	Set orientation to "COR"

PROBLEM RESOLUTION

This page left intentionally blank.

APPENDIX A

Font (FGID) Reference for HP LaserJet Printers

The following tables list the standard HP LaserJet resident fonts and the HP font cartridges that are available, along with the font ID number used to select the font.

For more information regarding font selection, refer to page 4-3 (Laser Printing).

APPENDIX A

Below is a key for the character set in the Symbol column in the tables on the following pages:

L1 Latin 1 Euro character set
 R8 Roman 8 character set
 850 Code Page 850 character set

Typeface	Symbol	Orient	Pitch	Point	Type-style No.
Line Printer	L1/R8/850	P/L	13.33	8.5	204
Line Printer	L1/R8/850	P/L	15	8.5	223
Line Printer	L1/R8/850	P/L	17.1	8.5	254
Line Printer	L1/R8/850	P/L	19	8.5	281
Courier	L1/R8/850	P/L	10	12	11
Courier Bold	L1/R8/850	P/L	10	12	46
Courier Italic	L1/R8/850	P/L	10	12	18
Courier	L1/R8/850	P/L	12	10	85
Courier Bold	L1/R8/850	P/L	12	10	88
Courier Italic	L1/R8/850	P/L	12	10	89
Letter Gothic	L1/R8/850	P/L	12	12	87
CG Times	L1/R8/850	P/L	Prop.	6	4605
	L1/R8/850	P/L	Prop.	8	4606
	L1/R8/850	P/L	Prop.	10	4607
	L1/R8/850	P/L	Prop.	12	4608
	L1/R8/850	P/L	Prop.	14	4609
	L1/R8/850	P/L	Prop.	18	4611
	L1/R8/850	P/L	Prop.	24	4614
	L1/R8/850	P/L	Prop.	30	4617

APPENDIX A

Typeface	Symbol	Orient	Pitch	Point	Type-style No.
CG Times Bold	L1/R8/850	P/L	Prop.	6	4625
	L1/R8/850	P/L	Prop.	8	4626
	L1/R8/850	P/L	Prop.	10	4627
	L1/R8/850	P/L	Prop.	12	4628
	L1/R8/850	P/L	Prop.	14	4629
	L1/R8/850	P/L	Prop.	18	4631
	L1/R8/850	P/L	Prop.	24	4634
	L1/R8/850	P/L	Prop.	30	4637
CG Times Italic	L1/R8/850	P/L	Prop.	6	4645
	L1/R8/850	P/L	Prop.	8	4646
	L1/R8/850	P/L	Prop.	10	4647
	L1/R8/850	P/L	Prop.	12	4648
	L1/R8/850	P/L	Prop.	14	4649
	L1/R8/850	P/L	Prop.	18	4651
	L1/R8/850	P/L	Prop.	24	4654
	L1/R8/850	P/L	Prop.	30	4657
CG Times Bold Italic	L1/R8/850	P/L	Prop.	6	4665
	L1/R8/850	P/L	Prop.	8	4666
	L1/R8/850	P/L	Prop.	10	4667
	L1/R8/850	P/L	Prop.	12	4668
	L1/R8/850	P/L	Prop.	14	4669
	L1/R8/850	P/L	Prop.	18	4671
	L1/R8/850	P/L	Prop.	24	4674
	L1/R8/850	P/L	Prop.	30	4677

APPENDIX A

Typeface	Symbol	Orient	Pitch	Point	Type-style No.
Univer Medium	L1/R8/850	P/L	Prop.	6	4805
	L1/R8/850	P/L	Prop.	8	4806
	L1/R8/850	P/L	Prop.	10	4807
	L1/R8/850	P/L	Prop.	12	4808
	L1/R8/850	P/L	Prop.	14	4809
	L1/R8/850	P/L	Prop.	18	4811
	L1/R8/850	P/L	Prop.	24	4812
	L1/R8/850	P/L	Prop.	30	4813
Univers Med Italic	L1/R8/850	P/L	Prop.	6	4825
	L1/R8/850	P/L	Prop.	8	4826
	L1/R8/850	P/L	Prop.	10	4827
	L1/R8/850	P/L	Prop.	12	4828
	L1/R8/850	P/L	Prop.	14	4829
	L1/R8/850	P/L	Prop.	18	4831
	L1/R8/850	P/L	Prop.	24	4834
	L1/R8/850	P/L	Prop.	30	4837
Univers Med Condensed	L1/R8/850	P/L	Prop.	6	4845
	L1/R8/850	P/L	Prop.	8	4846
	L1/R8/850	P/L	Prop.	10	4847
	L1/R8/850	P/L	Prop.	12	4848
	L1/R8/850	P/L	Prop.	14	4849
	L1/R8/850	P/L	Prop.	18	4851
	L1/R8/850	P/L	Prop.	24	4854
	L1/R8/850	P/L	Prop.	30	4857

APPENDIX A

Typeface	Symbol	Orient.	Pitch	Point	Type-style No.
Univers Med Cond. Italic	L1/R8/850	P/L	Prop.	6	4865
	L1/R8/850	P/L	Prop.	8	4866
	L1/R8/850	P/L	Prop.	10	4867
	L1/R8/850	P/L	Prop.	12	4868
	L1/R8/850	P/L	Prop.	14	4869
	L1/R8/850	P/L	Prop.	18	4871
	L1/R8/850	P/L	Prop.	24	4874
	L1/R8/850	P/L	Prop.	30	4877
ITC Zapf Dingbat	14L	P/L	Prop.	6	4985
	14L	P/L	Prop.	8	4986
	14L	P/L	Prop.	10	4987
	14L	P/L	Prop.	12	4988
	14L	P/L	Prop.	14	4989
	14L	P/L	Prop.	18	4991
	14L	P/L	Prop.	24	4994
	14L	P/L	Prop.	30	4997
General Font Assignments					
Times	L1/R8/850	P	Prop.	8	157
Times	L1/R8/850	P	Prop.	10	158
Times Bold	L1/R8/850	P	Prop.	10	159
Times Italic	L1/R8/850	P	Prop.	10	155
Helvetica Bold	L1/R8/850	P	Prop.	14.4	34126
Courier Bold	L1/R8/850	P/L	10	12	46
Courier Italic	L1/R8/850	P/L	10	12	18
Prestige	L1/R8/850	P/L	12	10	86
Prestige Bold	L1/R8/850	P/L	12	10	111
Prestige Italic	L1/R8/850	P/L	12	10	112

APPENDIX A

Typeface	Symbol	Orient.	Pitch	Point	Type-style No.
General Font Assignments					
Letter Gothic	L1/R8/850	P/L	12	12	87
Letter Gothic Bold	L1/R8/850	P/L	12	12	110
Letter Gothic Italic	L1/R8/850	P/L	12	10	112
Helvetica	ASCII	P	Prop.	6	181
Helvetica	ASCII	P	Prop.	8	183
Helvetica Bold	ASCII	P	Prop.	8	182
Helvetica Bold	ASCII	P	Prop.	10	185
Helvetica Bold	ASCII	P	Prop.	12	188
Helvetica Bold	ASCII	P	Prop.	14	190
Tax Line Draw	LinDrw-7	P	10	12	34
Letter Gothic	L1/R8/850	P	10	14.4	40
Letter Gothic	L1/R8/850	P	17.1	9.4	255
OCR-A 10N	OCR-A	P	10	12	19
OCR-B 10N	OCR-B	P	10	12	3
Code 3-9 4.6N	3 of 9	P	4.6	12	240
Code 3-9 9.3N	3 of 9	P	9.3	12	61
EAN/UPC Bold Bar Code	UPC	P	Prop.	12	171
EAN/UPC Bar Code	UPC	P	Prop.	12	170
ProCollection Cartridge					
Line Printer	ASCII	P/L	17.1	8.5	253
Courier Bold	ASCII	P/L	10	12	45
Courier Italic	ASCII	P/L	10	12	17
Courier	ASCII	P/L	12	10	85
Courier Bold	ASCII	P/L	12	10	108

APPENDIX A

Typeface	Symbol	Orient.	Pitch	Point	Type-style No.
ProCollection Cartridge (cont.)					
Courier Italic	ASCII	P/L	12	10	92
Courier	Legal	P	10	12	51
Couier Bold	Legal	P	10	12	52
Courier Italic	Legal	P	10	10	53
Courier	Legal	P	12	10	93
Courier Bold	Legal	P	12	10	94
Courier Italic	Legal	P	12	10	95
Prestige Elite	ASCII	P/L	15	7	220
Prestige Elite	ASCII	P/L	12	10	83
Prestige Elite Bold	ASCII	P/L	12	10	113
Prestige Elite Italic	ASCII	P/L	12	10	114
Prestige Elite	Legal	P	15	7	219
Prestige Elite	Legal	P	12	10	97
Prestige Elite Bold	Legal	P	12	10	98
Prestige Elite Italic	Legal	P	12	10	99
Letter Gothic	ASCII	P/L	27	3.6	291
Letter Gothic	ASCII	P/L	19	6	281
Letter Gothic	ASCII	P/L	17.1	9.5	257
Letter Gothic	ASCII	P/L	12	12	66
Letter Gothic Bold	ASCII	P/L	12	12	69
Letter Gothic Italic	ASCII	P/L	12	12	68
Times Roman	ASCII	P	Prop.	8	163
Times Roman	ASCII	P	Prop.	10	164

APPENDIX A

Typeface	Symbol	Orient	Pitch	Point	Type-style No.
Times Roman Bold	ASCII	P	Prop.	10	165
Times Roman Italic	ASCII	P	Prop.	10	166
Times Roman	ASCII	P	Prop.	12	167
Times Roman Bold	ASCII	P	Prop.	12	168
Times Roman Italic	ASCII	P	Prop.	12	169
Times Roman	Legal	P	Prop.	8	173
Times Roman	Legal	P	Prop.	10	174
Times Roman Bold	Legal	P	Prop.	10	175
Times Roman Italic	Legal	P	Prop.	10	176
Times Roman	Legal	P	Prop.	12	177
Times Roman Bold	Legal	P	Prop.	12	178
Times Roman Italic	Legal	P	Prop.	12	179
Helvetica	ASCII	P	Prop.	8	183
Helvetica	ASCII	P	Prop.	10	184
Helvetica Bold	ASCII	P	Prop.	10	185
Helvetica Italic	ASCII	P	Prop.	10	186
Helvetica	ASCII	P	Prop.	12	187
Helvetic Bold	ASCII	P	Prop.	12	188
Helvetica Italic	ASCII	P	Prop.	12	189
Helvetica Bold	ASCII	P	Prop.	14	190
Helvetica Bold	Legal	P	Prop.	14	191
WordPerfect Cartridge					
CG Times	DskTop	P	Prop.	6	4685
CG Times	DskTop	P	Prop.	8	4686

APPENDIX A

Typeface	Symbol	Orient	Pitch	Point	Type-style No.
CG Times Bold	DskTop	P	Prop.	8	4706
CG Times Italic	DskTop	P	Prop.	8	4814
CG Times	DskTop	P	Prop.	10	4687
CG Times Bold	DskTop	P	Prop.	10	4707
CG Times Italic	DskTop	P	Prop.	10	4815
CG Times	DskTop	P	Prop.	12	4688
CG Times Bold	DskTop	P	Prop.	12	4708
CG Times Italic	DskTop	P	Prop.	12	4816
CG Times	DskTop	P	Prop.	14	4689
CG Times Bold	DskTop	P	Prop.	14	4709
CG Times Italic	DskTop	P	Prop.	14	4817
CG Times Bold	DskTop	P	Prop.	18	4711
CG Times Bold	DskTop	P	Prop.	24	4714
Univers	DskTop	P	Prop.	14	4789
Univers	DskTop	P	Prop.	18	4791
Univers	DskTop	P	Prop.	24	4794
Microsoft Cartridge					
Helvetica	L1/R8	P	Prop.	8	34102
Helvetica	L1/R8	P	Prop.	10	34103
Helvetica Bold	L1/R8	P	Prop.	10	34123
Helvetica Italic	L1/R8	P	Prop.	10	34231
Helvetica	L1/R8	P	Prop.	12	34104
Helvetic Bold	L1/R8	P	Prop.	12	34124
Helvetica Italic	L1/R8	P	Prop.	12	34232
Helv Bold	L1/R8	P	Prop.	14	34125

APPENDIX A

Typeface	Symbol	Orient	Pitch	Point	Type-style No.
TmsRmn	L1/R8	P	Prop.	8	5686
TmsRmn	L1/R8	P	Prop.	10	5687
TmsRmn Bold	L1/R8	P	Prop.	10	5707
TmsRmn Italic	L1/R8	P	Prop.	10	5815
Times Roman	L1/R8	P	Prop.	12	5688
Times Roman Bold	L1/R8	P	Prop.	12	5708
Times Roman Italic	L1/R8	P	Prop.	12	5816
Times Roman Bold	L1/R8	P	Prop.	14	5709
Line Printer	L1/R8	P	Prop.	835	223
Polished Worksheet Cartridge					
Prestige Elite	L1/R8/850	P/L	15	7	221
Prestige Elite	L1/R8/850	P/L	12	10	86
Prestige Elite Bold	L1/R8/850	P/L	12	10	111
Prestige Elite Italic	L1/R8/850	P/L	12	10	112
Prestige Elite	Legal	P/L	15	7	219
Prestige Elite	Legal	P/L	12	10	97
Prestige Elite Bold	Legal	P/L	12	10	98
Prestige Elite Italic	Legal	P/L	12	10	99
Letter Gothic	L1/R8	P/L	27	3.6	290
Letter Gothic	L1/R8/850	P/L	12	12	87
Letter Gothic Bold	L1/R8/850	P/L	12	12	110
Letter Gothic Italic	Legal	P/L	12	12	109
Letter Gothic	Legal	P/L	27	3.6	292
Letter Gothic	Legal	P/L	12	12	90
Letter Gothic Bold	Legal	P/L	12	12	107
Letter Gothic Italic	Legal	P/L	12	12	106

APPENDIX A

Typeface	Symbol	Orient	Pitch	Point	Type-style No.
Presentation Bold	ASCII	P/L	8.1	16	434
Presentation Bold	Legal	P/L	8.1	16	431
Persuasive Presentations Cartridge					
Letter Gothic	ASCII	P/L	10	14	39
Letter Gothic	Legal	P/L	10	14	38
Presentation Bold	ASCII	P/L	10	14	6
Presentation Bold	Legal	P/L	10	14	7
Presentation bold	ASCII	P/L	8.1	16	434
Presentation bold	Legal	P/L	8.1	16	431
Presentation bold	ASCII	P/L	6.5	18	435
Presentation bold	Legal	P/L	6.5	18	432
Presentation bold	ASCII	P/L	5.7	24	436
Presentation bold	Legal	P/L	5.7	24	433
Helv Outline	ASCII	P/L	Prop.	24	34115
Helv Outline	Legal	P/L	Prop.	24	34116
Serifa	ASCII	P/L	Prop.	24	34215
Serifa	Legal	P/L	Prop.	24	34216
Line Draw	LinDrw	P/L	10	14	31
PC Line bold	PCLin	P/L	10	14	32
Forms, Etc. Cartridge					
Univers	L1/R8/850	P/L	Prop.	6	33101
Univers	L1/R8/850	P/L	Prop.	8	33102
Univers bold	L1/R8/850	P/L	Prop.	8	33122
Univers bold	L1/R8/850	P/L	Prop.	10	33123
Univers bold	L1/R8/850	P/L	Prop.	12	33124
Univers bold	L1/R8/850	P/L	Prop.	14	33125
Helv Cond. Black bold	TXNum	P/L	Prop.	24	34128
OCR-A	OCR-A	P	10	12	19

APPENDIX A

Typeface	Symbol	Orient	Pitch	Point	Type-style No.
Tax Line Draw	Taxlin Drw	P/L	10	12	30
Bar Codes & More Cartridge					
Letter Gothic	L1/R8	P/L	15	9.5	230
Letter Gothic	L1/R8	P/L	112	12	87
Letter Gothic	L1/R8	P/L	10	14	40
OCR-A	OCR-A	P	10	12	19
OCR-B	OCR-B	P	10	12	3
Code 3 of 9	3 of 9	P	8.1	12	60
Code 3 of 9	3 of 9	P	4.6	12	240
EAN/UPC 10 Mil	UPC	P	Prop.	12	170
EAN/UPC 13 Mil bold	UPC	P	Prop.	12	171
USPS Zip	ZIP	P/L	Prop.	12	172
Line Draw	LinDrw	P/L	10	12	33
Text Equations Cartridge					
Prestige Elite	L1/R8	P	15	7	221
Prestige Elite	L1/R8	P	17.1	7	256
Prestige Elite	L1/R8	P	12	10	86
Prestige Elite bold	L1/R8	P	12	10	111
Prestige Elite italic	L1/R8	P	12	10	112
CG Times	L1/R8	P	Prop.	8	157
CG Times	L1/R8	P	Prop.	10	158
CG Times bold	L1/R8	P	Prop.	10	159
CG Times italic	L1/R8	P	Prop.	10	155
Global Text Cartridge					
CG Century Schoolbook	L1/R8/850	P/L	Prop.	8	16950
CG Century Schoolbook	L1/R8/850	P/L	Prop.	10	16951
CG Century Schlbk Bold	L1/R8/850	P/L	Prop.	10	16971
CG Century Schlbk Italic	L1/R8/850	P/L	Prop.	10	17079

APPENDIX A

Typeface	Symbol	Orient.	Pitch	Point	Type-style No.
CG Triumvirate	L1/R8	P/L	Prop.	10	33335
CG Triumvirate Bold	L1/R8	P/L	Prop.	14	33357
Optional Fonts as originally found in Pretty Faces Cartridge					
Microstyle	ASCII	P	Prop.	18	5910
Microstyle Bold	ASCII	P	Prop.	36	5920
Hobo Medium	ASCII	P	Prop.	30	5930
Hobo Medium	ASCII	P	Prop.	14	5940
Thunderbird	ASCII	P	Prop.	54	5950
Signet Roundhand	ASCII	P	Prop.	18	5960
Signet Roundhand	ASCII	P	Prop.	14	5970
ITC Dingbats	ITC	P	Prop.	36	5980
ITC Dingbats	ITC	P	Prop.	18	5990

APPENDIX A

This page left intentionally blank.

APPENDIX B

Character Sets

The IBM 3812-1 printer emulation supports both the Roman 8 character set and Code Page 850. The IBM 4214, 5224, 5225, and 5256 printer emulations support both the Code Page 850 and Code Page 437 character sets. For Euro symbol support, two new character sets have been added: Windows 3.1 Latin 1 Euro and Code Page 858. The selection between the available character sets decides which is used when a font is supported by all character sets. Refer to the printer's user's guide for illustrations and information on character sets.

APPENDIX B

Roman-8 Symbol Set

Includes US ASCII (dec. 1-127) and Roman Extension Symbol Sets

	0	1	2	3	4	5	6	7	8	9	A	B	C	D	E	F
0	NUL 0	DLE 16		0 48	@ 64	P 80	' 96	p 112			- 160	â 176	Å 192	Á 208	À 224	Þ 240
1	SOH 1	DC1 17	! 33	1 49	A 65	Q 81	a 97	q 113			À 161	Ý 177	ê 193	î 209	Ã 225	þ 241
2	STX 2	DC2 18	" 34	2 50	B 66	R 82	b 98	r 114			Â 162	ý 178	ô 194	Ø 210	ã 226	. 242
3	ETX 3	DC3 19	# 35	3 51	C 67	S 83	c 99	s 115			È 163	° 179	û 195	Æ 211	Ð 227	µ 243
4	EOT 4	DC4 20	\$ 36	4 52	D 68	T 84	d 100	t 116			Ê 164	Ç 180	á 196	â 212	ð 228	¶ 244
5	ENQ 5	NAK 21	% 37	5 53	E 69	U 85	e 101	u 117			Ë 165	ç 181	é 197	í 213	Í 229	¾ 245
6	ACK 6	SYN 22	& 38	6 54	F 70	V 86	f 102	v 118			Ï 166	Ñ 182	ó 198	ø 214	Ï 230	— 246
7	BEL 7	ETB 23	' 39	7 55	G 71	W 87	g 103	w 119			ÿ 167	ñ 183	ú 199	æ 215	Ó 231	¼ 247
8	BS 8	CAN 24	(40	8 56	H 72	X 88	h 104	x 120			ı 168	à 184	Ä 200	Ò 216	Ö 232	½ 248
9	HT 9	EM 25) 41	9 57	I 73	Y 89	i 105	y 121			˘ 169	ı 185	è 201	ì 217	Õ 233	ª 249
A	LF 10	SUB 26	* 42	: 58	J 74	Z 90	j 106	z 122			ˆ 170	ƒ 186	ò 202	Ö 218	õ 234	° 250
B	VT 11	ESC 27	+ 43	; 59	K 75	[91	k 107	{ 123			˙ 171	£ 187	ù 203	Û 219	š 235	« 251
C	FF 12	FS 28	, 44	< 60	L 76	\ 92	l 108	 124			˜ 172	¥ 188	ä 204	É 220	š 236	■ 252
D	CR 13	GS 29	- 45	= 61	M 77] 93	m 109	} 125			Û 173	§ 189	ë 205	ÿ 221	Ú 237	» 253
E	SO 14	RS 30	. 46	> 62	N 78	^ 94	n 110	~ 126			Û 174	f 190	ö 206	ß 222	ÿ 238	± 254
F	SI 15	US 31	/ 47	? 63	O 79	_ 95	o 111	☒ 127			£ 175	ç 191	ü 207	Ô 223	ÿ 239	

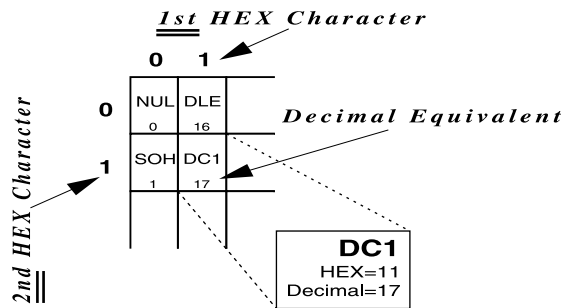

APPENDIX B

Code Page 850 Symbol Set

	0	1	2	3	4	5	6	7	8	9	A	B	C	D	E	F
0	NUL 0	▶ 16	 32	0 48	@ 64	P 80	` 96	p 112	Ç 128	É 144	á 160	☐ 176	⌒ 192	ð 208	Ó 224	- 240
1	☺ 1	◀ 17	! 33	1 49	A 65	Q 81	a 97	q 113	ü 129	æ 145	í 161	☒ 177	⊥ 193	Ð 209	β 225	± 241
2	☺ 2	↕ 18	" 34	2 50	B 66	R 82	b 98	r 114	é 130	Æ 146	ó 162	☒ 178	⊥ 194	Ê 210	Ô 226	= 242
3	♥ 3	!! 19	# 35	3 51	C 67	S 83	c 99	s 115	â 131	ô 147	ú 163	 179	⊥ 195	È 211	Ò 227	¼ 243
4	♦ 4	¶ 20	\$ 36	4 52	D 68	T 84	d 100	t 116	ä 132	ö 148	ñ 164	⊥ 180	— 196	È 212	ø 228	¶ 244
5	♣ 5	§ 21	% 37	5 53	E 69	U 85	e 101	u 117	à 133	ò 149	Ñ 165	Á 181	⊥ 197	ı 213	Ö 229	§ 245
6	♠ 6	— 22	& 38	6 54	F 70	V 86	f 102	v 118	â 134	û 150	ª 166	Â 182	ã 198	Í 214	μ 230	÷ 246
7	● 7	↕ 23	' 39	7 55	G 71	W 87	g 103	w 119	ç 135	ù 151	º 167	À 183	Ã 199	Î 215	þ 231	¿ 247
8	◼ 8	↑ 24	(40	8 56	H 72	X 88	h 104	x 120	ê 136	ÿ 152	¿ 168	© 184	⌒ 200	Ï 216	þ 232	° 248
9	○ 9	↓ 25) 41	9 57	I 73	Y 89	i 105	y 121	ë 137	ÿ 153	® 169	⌒ 185	⌒ 201	⌒ 217	Ú 233	¨ 249
A	◼ 10	→ 26	* 42	: 58	J 74	Z 90	j 106	z 122	è 138	Û 154	¬ 170	⌒ 186	⌒ 202	⌒ 218	Û 234	. 250
B	♂ 11	← 27	+ 43	; 59	K 75	[91	k 107	{ 123	ï 139	ø 155	½ 171	⌒ 187	⌒ 203	◼ 219	Û 235	¹ 251
C	♀ 12	↔ 28	, 44	< 60	L 76	\ 92	 108	 124	î 140	£ 156	¼ 172	⌒ 188	⌒ 204	◼ 220	ý 236	³ 252
D	🎵 13	↔ 29	- 45	= 61	M 77] 93	m 109	} 125	ì 141	Ø 157	ı 173	¢ 189	== 205	 221	Ý 237	² 253
E	🎵 14	▲ 30	. 46	> 62	N 78	^ 94	n 110	~ 126	Ä 142	× 158	« 174	¥ 190	⌒ 206	Ï 222	- 238	■ 254
F	☼ 15	▼ 31	/ 47	? 63	O 79	_ 95	o 111	⌒ 127	Å 143	f 159	» 175	⌒ 191	⌒ 207	◼ 223	' 239	 255

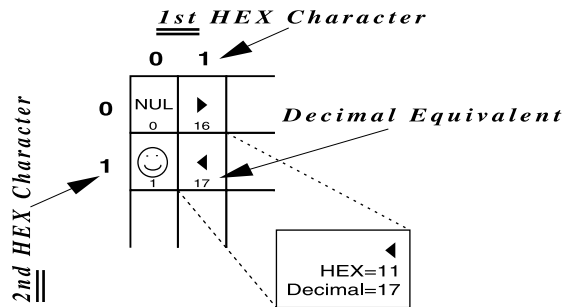

APPENDIX B

Code Page 858 Symbol Set

	0	1	2	3	4	5	6	7	8	9	A	B	C	D	E	F
0	NUL 0	▶ 16		0 48	@ 64	P 80	` 96	p 112	Ç 128	É 144	á 160	☐ 176	┌ 192	ð 208	Ó 224	- 240
1	☺ 1	◀ 17	! 33	1 49	A 65	Q 81	a 97	q 113	ü 129	æ 145	í 161	☒ 177	└ 193	Ð 209	β 225	± 241
2	☹ 2	↕ 18	" 34	2 50	B 66	R 82	b 98	r 114	é 130	Æ 146	ó 162	☒ 178	┘ 194	Ê 210	Ô 226	= 242
3	♥ 3	!! 19	# 35	3 51	C 67	S 83	c 99	s 115	â 131	ô 147	ú 163	 179	┘ 195	Ë 211	Ò 227	¾ 243
4	♦ 4	¶ 20	\$ 36	4 52	D 68	T 84	d 100	t 116	ä 132	ö 148	ñ 164	┘ 180	— 196	È 212	õ 228	¶ 244
5	♣ 5	§ 21	% 37	5 53	E 69	U 85	e 101	u 117	à 133	ò 149	Ñ 165	Á 181	⊕ 197	€ 213	Õ 229	§ 245
6	♠ 6	— 22	& 38	6 54	F 70	V 86	f 102	v 118	ã 134	û 150	ª 166	Â 182	ã 198	Í 214	μ 230	÷ 246
7	● 7	↕ 23	' 39	7 55	G 71	W 87	g 103	w 119	ç 135	ù 151	º 167	À 183	Ã 199	Î 215	þ 231	¸ 247
8	◼ 8	↑ 24	(40	8 56	H 72	X 88	h 104	x 120	ê 136	ÿ 152	¿ 168	© 184	└ 200	Ï 216	þ 232	º 248
9	◯ 9	↓ 25) 41	9 57	I 73	Y 89	i 105	y 121	ë 137	ÿ 153	® 169	≡ 185	┘ 201	Ú 217	· 233	· 249
A	◼ 10	→ 26	* 42	: 58	J 74	Z 90	j 106	z 122	è 138	Û 154	¬ 170	 186	┘ 202	Û 218	· 234	· 250
B	♂ 11	← 27	+ 43	; 59	K 75	[91	k 107	{ 123	ï 139	ø 155	½ 171	┘ 187	┘ 203	◼ 219	Û 235	1 251
C	♀ 12	└ 28	, 44	< 60	L 76	\ 92	l 108	l 124	î 140	£ 156	¼ 172	┘ 188	┘ 204	◼ 220	ý 236	3 252
D	🎵 13	↔ 29	- 45	= 61	M 77] 93	m 109	} 125	ì 141	Ø 157	¡ 173	≡ 189	≡ 205	Û 221	Ý 237	2 253
E	🎵 14	▲ 30	. 46	> 62	N 78	^ 94	n 110	~ 126	Ä 142	× 158	« 174	¥ 190	┘ 206	Û 222	— 238	■ 254
F	☼ 15	▼ 31	/ 47	? 63	O 79	_ 95	o 111	◊ 127	Å 143	f 159	» 175	┘ 191	◻ 207	◼ 223	◊ 239	

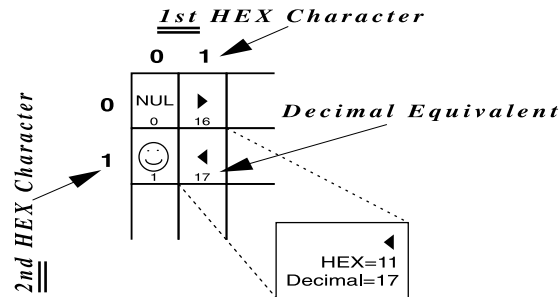

APPENDIX B

Latin 1 Euro Symbol Set

Includes US ASCII (dec. 1-127) and Windows 3.1 Latin 1 Extension Symbol Sets

	0	1	2	3	4	5	6	7	8	9	A	B	C	D	E	F
0	NUL 0	DLE 16	SP 32	0 48	@ 64	P 80	˘ 96	p 112	€ 128		NBS 144	° 160	À 176	Ð 192	à 208	ð 224
1	SOH 1	DC1 17	! 33	1 49	A 65	Q 81	a 97	q 113	‘ 129	í 145	± 161	Á 177	Ñ 193	á 209	ñ 225	
2	STX 2	DC2 18	" 34	2 50	B 66	R 82	b 98	r 114	, 130	’ 146	¢ 162	2 178	Â 194	Ò 210	â 226	ò 242
3	ETX 3	DC3 19	# 35	3 51	C 67	S 83	c 99	s 115	f 131	“ 147	£ 163	3 179	Ã 195	Ó 211	ã 227	ó 243
4	EOT 4	DC4 20	\$ 36	4 52	D 68	T 84	d 100	t 116	„ 132	” 148	¤ 164	´ 180	Ä 196	Ô 212	ä 228	ô 244
5	ENQ 5	NAK 21	% 37	5 53	E 69	U 85	e 101	u 117	... 133	• 149	¥ 165	µ 181	Å 197	Õ 213	å 229	õ 245
6	ACK 6	SYN 22	& 38	6 54	F 70	V 86	f 102	v 118	† 134	- 150	¡ 166	¶ 182	Æ 198	Ö 214	æ 230	ö 246
7	BEL 7	ETB 23	' 39	7 55	G 71	W 87	g 103	w 119	‡ 135	— 151	§ 167	· 183	Ç 199	× 215	ç 231	÷ 247
8	BS 8	CAN 24	(40	8 56	H 72	X 88	h 104	x 120	^ 136	~ 152	¨ 168	˚ 184	È 200	Ø 216	è 232	ø 248
9	HT 9	EM 25) 41	9 57	I 73	Y 89	i 105	y 121	‰ 137	™ 153	© 169	¡ 185	É 201	Û 217	é 233	ù 249
A	LF 10	SUB 26	* 42	: 58	J 74	Z 90	j 106	z 122	Š 138	š 154	ª 170	º 186	Ê 202	Ú 218	ê 234	ú 250
B	VT 11	ESC 27	+ 43	; 59	K 75	[91	k 107	{ 123	< 139	> 155	« 171	» 187	Ë 203	Û 219	ë 235	û 251
C	FF 12	FS 28	, 44	< 60	L 76	\ 92	l 108	 124	Œ 140	œ 156	¬ 172	¼ 188	Ì 204	Ü 220	ì 236	ü 252
D	CR 13	GS 29	- 45	= 61	M 77] 93	m 109	} 125			- 173	½ 189	Í 205	Ý 221	í 237	ý 253
E	SO 14	RS 30	. 46	> 62	N 78	^ 94	n 110	~ 126			® 174	¾ 190	Î 206	Þ 222	î 238	þ 254
F	SI 15	US 31	/ 47	? 63	O 79	_ 95	o 111	☐ 127		ÿ 143	— 159	¿ 175	Ï 191	ß 207	ï 223	ÿ 255

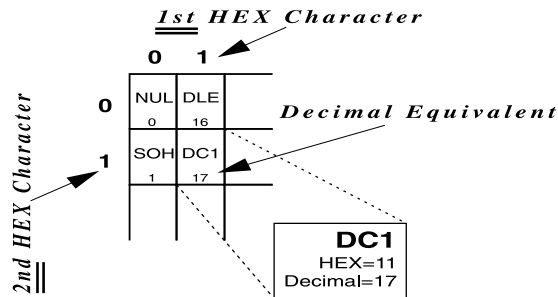

APPENDIX B

This page left intentionally blank.

APPENDIX C

Serial Port Specifications

The I-O Print Box CxS plus uses a standard, RS-232-C, 25-pin serial printer cable for connection to a serial printer and for connection to a serial PC/LAN print server port.

The Print Box's input and output connectors use the same pin assignments. They are:

Shell:	Chassis Ground
1:	Chassis Ground
2:	Transmit (TXD)output
3:	Receive (RXD)input
4:	Request To Send (RTS)output
5:	Clear To Send (CTS)input
6:	Data Set Ready (DSR)input
7:	Signal Ground
8-19:	No connection
20:	Data Terminal Ready (DTR) . . output

The serial printer cable shipped with the I-O Print Box CxS has the following pin assignments:

DB25F	DB25M
Shell	Shell
2	3
3	2
5, 6, 8	20
7	7
20	5,6,8

This pin out will work with most PCs and printers (i.e. the supplied cable can be used as either sharing cable or printer cable). When used to connect the printer to the print box, the cable's female side (DB25F) is connected to the Print Box. When used as a sharing cable, the male end (DB25M) is connected to the I-O Print Box.

APPENDIX C

This page left intentionally blank.

APPENDIX D**Parallel Port Specifications**

The I-O Print Box CxP plus and CxP lite use standard 36-pin/25-pin Centronics printer cables for connection to a parallel printer and to connect a parallel PC/LAN printer server port. (The Print Box CxP lite uses the connection to the PC/LAN for interface configuration only.)

The 25-pin connector on the Print Box label "Parallel Out To Printer" has the following pin assignments:

Pin Number	Direction	Name
1	Output	nStrobe
2-9	Output	Data 1 - Data 8
10	Input	nAck
11	Input	Busy
12	Input	PError
13	Input	Select
14	Output	nAutoFd (always high)
15	Input	nFault
16	Output	nInit (always high)
17	Output	nSelectIn (held low)
18-25		Signal Ground
Shell		Chassis Ground

APPENDIX D

The 36-pin connector on the Print Box labeled "Parallel In From PC/LAN" (CxP plus) and "Parallel Setup Port From PC/LAN" uses the following pin assignment:

Pin Number	Direction	Name
1	Input	nStrobe
2-9	Input	Data 1 - Data 8
10	Output	nAck
11	Output	Busy
12	Output	PError
13	Output	Select
14, 15		No connection
16		Signal Ground
17		Chassis Ground
18	Output	Optional +5V (350mA max)
19-30		Signal Ground
31	Input	nInit (an Acknowledge will be generated in response to this input going active, however, the interface will not be reset)
32	Input	nFault
33		Signal Ground
34-36		No connection
Shell		Chassis Ground

APPENDIX E

Transferring Power to Pin 18

To transfer power to pin 18 of the parallel input connector of the Print Box CxP plus, a jumper must be moved on the interface board. To move this jumper do the following:

1. Power off the printer, the Print Box, and the attached PC or LAN print server.
2. Disconnect all cables from the Print Box.
3. Remove the two black screws from the outside of the back panel.
4. Pull out the interface's back panel, together with the attached board.
5. Locate the jumper in the lower left corner, right above the parallel connector labeled "Parallel In From PC/LAN" (see Figure 1).
6. Remove the black jumper from the pin, then reinsert it covering both pins (see Figures 1a and 1b).

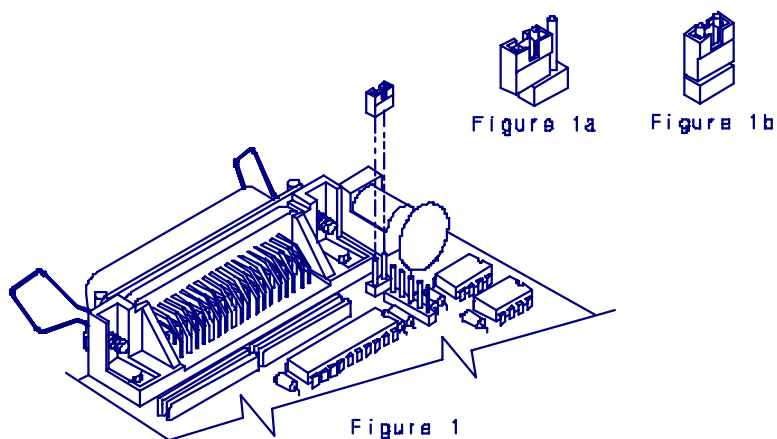

APPENDIX E

7. Slide the interface board back into the bottom groove of the chassis.
8. Tighten the black screws on the back panel.
9. Connect the printer and the PC/LAN to the Print Box, then connect the power cord.
10. Turn on the printer, then the I-O Print Box.

WARRANTY INFORMATION

Manufacturer's One Year Limited Warranty (United States)

The following warranty applies only to products purchased and operated within the United States.

I-O Corporation (I-O) warrants this product against defects in material and workmanship for a period of one year commencing from date of purchase by the original customer, when operated and maintained in accordance with I-O's published specifications. I-O's liability shall be limited, at its option and expense, to refund to buyer the actual amount paid by buyer or to repair or replace any defective or nonconforming product or part thereof, F.O.B. I-O's authorized repair depot. Buyer may obtain a replacement product by meeting the terms of the I-O Customer On-Site Exchange Repair Policy in effect at the time of the request.

THE EXPRESS WARRANTY SET FORTH ABOVE IS IN LIEU OF ALL OTHER EXPRESS OR IMPLIED WARRANTIES. OTHERWISE, THE PRODUCTS ARE SOLD AS IS WITHOUT FURTHER OBLIGATION OR LIABILITY ON THE PART OF I-O. I-O EXPRESSLY EXCLUDES ANY IMPLIED WARRANTIES OF MERCHANTABILITY AND FITNESS FOR A PARTICULAR PURPOSE.

EXCEPT AS EXPRESSLY SET FORTH HEREIN, IN NO EVENT SHALL I-O BE LIABLE FOR ANY CLAIMS OR DAMAGE ARISING DIRECTLY OR INDIRECTLY FROM THE FURNISHING OR FAILURE TO FURNISH PRODUCTS, SPARE OR REPLACEMENT PARTS, INFORMATION OR SERVICES HEREUNDER. UNDER NO CIRCUMSTANCES SHALL I-O BE LIABLE IN ANY WAY FOR INDIRECT, SPECIAL OR CONSEQUENTIAL DAMAGES, INCLUDING, BUT NOT LIMITED TO LOST BUSINESS OR PROFITS, WHETHER OR NOT FORESEEABLE AND WHETHER OR NOT BASED ON BREACH OF WARRANTY, CONTRACT, OR NEGLIGENCE.

Warranty

WARRANTY INFORMATION

This page left intentionally blank.

WARRANTY INFORMATION

Customer On-Site Exchange Repair Policy

Terms, Conditions, and Limitations

Effective May 1, 1994^a

For products covered by the I-O Corporation (I-O) Manufacturer's Limited Warranty (United States), I-O's Customer On-Site Exchange (COE) Repair Policy provides customers with a replacement unit for a defective product, subject to the following terms and conditions:

Call Customer Support

- If a product fails call I-O Customer Support for assistance at (801) 972-1446.

Verify Product Failure

- I-O will verify the product serial number, warranty coverage and product failure.
- * You are responsible for assisting in verifying the product failure.
- When I-O Customer Support verifies a product failure they will issue a Return Merchandise Authorization (RMA) number for the failed product.

Replacement Units

- Replacement units are shipped from I-O's stock of refurbished units, subject to availability.
- Replacement units carry the same warranty as remaining on the original product.
- I-O's COE Repair Policy applies only to warranted product failures. Buyer guarantees payment for non-warranted product repairs or replacement.

WARRANTY INFORMATION

Customer On-Site Exchange Repair Policy

(Continued)

Return Your Failed Unit

- When you return the failed product it must be shipped freight prepaid. Always note the RMA number on the outside of the package.

Install the Replacement Unit

- You are responsible for installing the replacement unit.
- After receiving the replacement unit please call I-O Customer Support if any assistance is required.

^a I-O reserves the right to change the terms and conditions of this policy without notice.

WARRANTY INFORMATION

Manufacturer's One Year Limited Warranty (International)

The following warranty applies only to products purchased or operated outside the United States.

I-O Corporation (I-O) warrants this product against defects in material and workmanship for a period of one year commencing from date of purchase by the original customer, when operated and maintained in accordance with I-O's published specifications. I-O's liability shall be limited, at its option and expense, to refund to buyer the actual amount paid by buyer or to repair or replace any defective or nonconforming product or part thereof, F.O.B. I-O's authorized repair depot. Buyer may obtain warranty service by meeting the terms of the I-O Return-to-Depot Repair Policy in effect at the time of the request.

THE EXPRESS WARRANTY SET FORTH ABOVE IS IN LIEU OF ALL OTHER EXPRESS OR IMPLIED WARRANTIES. OTHERWISE, THE PRODUCTS ARE SOLD AS IS WITHOUT FURTHER OBLIGATION OR LIABILITY ON THE PART OF I-O. I-O EXPRESSLY EXCLUDES ANY IMPLIED WARRANTIES OF MERCHANTABILITY AND FITNESS FOR A PARTICULAR PURPOSE.

EXCEPT AS EXPRESSLY SET FORTH HEREIN, IN NO EVENT SHALL I-O BE LIABLE FOR ANY CLAIMS OR DAMAGE ARISING DIRECTLY OR INDIRECTLY FROM THE FURNISHING OR FAILURE TO FURNISH PRODUCTS, SPARE OR REPLACEMENT PARTS, INFORMATION OR SERVICES HEREUNDER. UNDER NO CIRCUMSTANCES SHALL I-O BE LIABLE IN ANY WAY FOR INDIRECT, SPECIAL OR CONSEQUENTIAL DAMAGES, INCLUDING, BUT NOT LIMITED TO LOST BUSINESS OR PROFITS, WHETHER OR NOT FORESEEABLE AND WHETHER OR NOT BASED ON BREACH OF WARRANTY, CONTRACT, OR NEGLIGENCE.

WARRANTY INFORMATION

This page left intentionally blank.

WARRANTY INFORMATION

Return-to-Depot Repair Policy

Terms, Conditions, and Limitations

Effective May 1, 1994^a

For products covered by the I-O Corporation (I-O) Manufacturer's Limited Warranty (International), I-O's Return-to-Depot (RTD) Repair Policy provides customers with warranty service for a defective product, subject to the following terms and conditions:

Call Customer Support

- If a product fails call I-O Customer Support for assistance at:

(801) 972-1446 for all locations outside the United States.

Verify Product Failure

- I-O will verify the product serial number, warranty coverage and product failure.
- You are responsible for assisting in verifying the product failure
- When I-O Customer Support verifies a product failure they will issue a Return Merchandise Authorization (RMA) number to authorize return of the failed product.

Select Your Preferred Repair Location

- I-O's Customer Support Representative will assist you in identifying the nearest I-O authorized repair depot.
- I-O's Customer Support Representative will provide you with an RMA transmittal form referencing the assigned RMA number and the authorized repair depot address.

WARRANTY INFORMATION

Return-to-Depot Repair Policy

(Continued)

Return Your Failed Unit

- Return the failed product to the I-O authorized repair depot previously identified, enclosing the RMA transmittal form. When you return the failed product it must be shipped freight prepaid.
- I-O's RTD Repair Policy applies only to warranted product failures. Buyer guarantees payment for non-warranted product repairs.

Install Your Repaired Unit

- I-O's authorized repair depot will service the faulty unit and return it to you, freight prepaid.
- You are responsible for installing the returned unit.
- After receiving the repaired unit please call I-O Customer Support if any assistance is required.

^a I-O reserves the right to change the terms and conditions of this policy without notice.

WARRANTY INFORMATION

Manufacturer's One Year Limited Warranty (European Area)

The following warranty applies only to products purchased and operated within the European Area.

I-O Corporation (I-O) warrants this product against defects in material and workmanship for a period of one year commencing from date of purchase by the original end-user, when operated and maintained in accordance with I-O's published specifications. I-O's liability shall be limited, at its option and expense, to refund to original end-user the actual amount paid by original end-user or to repair or replace any defective or nonconforming product or part thereof, F.O.B. I-O's authorized repair depot. Original end-user may obtain a replacement product by meeting the terms of the I-O Customer On-Site Exchange Repair Policy in effect at the time of the request.

THE EXPRESS WARRANTY SET FORTH ABOVE IS IN LIEU OF ALL OTHER EXPRESS OR IMPLIED WARRANTIES. OTHERWISE, THE PRODUCTS ARE SOLD AS IS WITHOUT FURTHER OBLIGATION OR LIABILITY ON THE PART OF I-O. I-O EXPRESSLY EXCLUDES ANY IMPLIED WARRANTIES OF MERCHANTABILITY AND FITNESS FOR A PARTICULAR PURPOSE.

EXCEPT AS EXPRESSLY SET FORTH HEREIN, IN NO EVENT SHALL I-O BE LIABLE FOR ANY CLAIMS OR DAMAGE ARISING DIRECTLY OR INDIRECTLY FROM THE FURNISHING OR FAILURE TO FURNISH PRODUCTS, SPARE OR REPLACEMENT PARTS, INFORMATION OR SERVICES HEREUNDER. UNDER NO CIRCUMSTANCES SHALL I-O BE LIABLE IN ANY WAY FOR INDIRECT, SPECIAL OR CONSEQUENTIAL DAMAGES, INCLUDING, BUT NOT LIMITED TO LOST BUSINESS OR PROFITS, WHETHER OR NOT FORESEEABLE AND WHETHER OR NOT BASED ON BREACH OF WARRANTY, CONTRACT, OR NEGLIGENCE.

WARRANTY INFORMATION

This page left intentionally blank.

WARRANTY INFORMATION

Customer On-Site Exchange Repair Policy

Terms, Conditions, and Limitations

Effective June 1, 1997^a

For products covered by the I-O Corporation (I-O) Manufacturer's Limited Warranty (European Area), I-O's Customer On-Site Exchange (COE) Repair Policy provides original end-users with a replacement unit for a defective product, subject to the following terms and conditions:

Call Customer Support

- If a product fails call I-O Customer Support for assistance at 44(0) 1908 567722.

Verify Product Failure

- I-O will verify the product serial number, warranty coverage and product failure.
- You are responsible for assisting in verifying the product failure.
- When I-O Customer Support verifies a product failure they will issue a Return Merchandise Authorization (RMA) number for the failed product.

I-O Ships Replacement Unit

- Replacement units are shipped from I-O's stock of refurbished units, subject to availability.
- I-O will invoice you for full retail value of the replacement unit upon shipment from I-O.
- Replacement units carry the same warranty as remaining on the original product.
- I-O's COE Repair Policy applies only to warranted product failures. You must pay for non-warranted product repairs or replacement.

WARRANTY INFORMATION

Customer On-Site Exchange Repair Policy

(Continued)

Return Your Failed Unit

- When you return the failed product it must be shipped freight prepaid. To insure proper tracking always note the RMA number on the outside of the package.
- I-O will issue you a credit (reversing the replacement unit invoice amount) when the failed product is received by I-O.
- If you do not return the failed product (or pay the replacement unit invoice) within 14 calendar days of the date the replacement unit is shipped from I-O, your warranty coverage and service will be suspended on all I-O products you own.

Install the Replacement Unit

- You are responsible for installing the replacement unit.
- After receiving the replacement unit please call I-O Customer Support if any assistance is required.

^a I-O reserves the right to change the terms and conditions of this policy without notice.

DECLARATION OF CONFORMITY

EUROPEAN COMMUNITY COMPLIANCE STATEMENT:

This product is in conformity with the protection requirements of EC Council Directives 72/23/EEC, and 89/336/EEC on the approximation of the laws of the Member States relating to: Standard EN60950 (Safety of Information Technology Equipment); Standard EN50082-1 (Generic Immunity Standard for Residential, Commercial, and Light Industrial Products); and Standard EN55022 (Limits and Methods of Measurement of Radio Interference from Information Technology Equipment).

WARNING: This is a Class A product. In a domestic environment this product may cause radio interference in which case the user may be required to take adequate measures.

DECLARATION OF CONFORMITY

This page left intentionally blank.